



**Mercedes-Benz**



**Operator's Manual**

**S 600**

## Product information

Kindly observe the following in your own best interest:

We recommend using Mercedes-Benz original parts as well as conversion parts and accessories explicitly approved by us for your vehicle model. We have tested these parts to determine their reliability, safety and their special suitability for Mercedes-Benz vehicles.

We are unable to make an assessment for other products and therefore cannot be held responsible for them, even if in individual cases an official approval or authorization by governmental or other agencies should exist. Use of such parts and accessories could adversely affect the safety, performance or reliability of your vehicle. Please do not use them. Mercedes-Benz original parts as well as conversion parts and accessories approved by us are available at your authorized Mercedes-Benz Center where you will receive comprehensive information, also on permissible technical modifications, and where proper installation will be performed.

Our company and staff congratulate you on the purchase of your new Mercedes-Benz.

Your selection of our product is a demonstration of your trust in our company name. Further, it exemplifies your desire to own an automobile that will be as easy as possible to operate and provide years of service.

Your Mercedes-Benz represents the efforts of many skilled engineers and craftsmen. To ensure your pleasure of ownership, and for your safety and that of your passengers, we ask you to make a small investment of your time:

- Please read this manual carefully before putting it aside. Then return it to your vehicle where it will be handy for your reference.
- Please abide by the recommendations contained in this manual. They are designed to acquaint you with the operation of your Mercedes-Benz.
- Please abide by the warnings and cautions contained in this manual. They are designed to help improve the safety of the vehicle operator and occupants.

We extend our best wishes for many miles of safe, pleasurable driving.

DaimlerChrysler AG

## Operator's manual

This Operator's Manual contains a great deal of useful information. We urge you to read it carefully and familiarize yourself with the vehicle before driving.

For your own safety and longer service life of the vehicle, we urge you to follow the instructions and warnings contained in this manual. Ignoring them could result in damage to the vehicle or personal injury to you or others. Vehicle damage caused by failure to follow instructions is not covered by the Mercedes-Benz Limited Warranty.

Your vehicle may have some or all of the equipment described in this manual. Therefore, you may find explanations for optional equipment not installed in your vehicle. If you have any questions about the operation of any equipment, your authorized Mercedes-Benz Center will be glad to demonstrate the proper procedures.

### Owner's Service and Warranty Policy

The Owner's Service and Warranty Information Booklet contains detailed information about the warranties covering your Mercedes-Benz, including:

- New Car Limited Warranty,
- Emission System Warranty,
- Emission Performance Warranty,
- State Warranty Enforcement Laws (Lemon Laws).

### **Important notice for California retail buyers of Mercedes-Benz automobiles**

Under California law you may be entitled to a replacement of your vehicle or a refund of the purchase price, if Mercedes-Benz USA, LLC or its authorized Mercedes-Benz Center fails to conform the vehicle to its express warranties after a reasonable number of repair attempts during the period of one year or 12 000 miles from original delivery of the vehicle. A reasonable number of repair attempts is presumed for a retail buyer (1) if the vehicle is out of service by reason of repair of substantial nonconformities for a cumulative total of more than 30 calendar days or (2) the same substantial non-conformity has been subject to repair four or more times **and you have at least once directly notified us in writing of the need to repair the non-conformity and have given us an opportunity to perform the repair ourselves. Notifications should be sent to the nearest Mercedes-Benz Regional Office listed in the Service and Warranty Information Booklet.**

### **Maintenance**

The Service Booklet describes all the necessary maintenance work which should be performed at regular intervals.

Always have the Service Booklet with you when you take the vehicle to your authorized Mercedes-Benz Center for service. The service advisor will record each service in the booklet for you.

### **Roadside assistance**

The Mercedes-Benz Roadside Assistance Program provides factory trained technical help in the event of a breakdown. Calls to the toll-free Roadside Assistance number:

**1-800-222-0100 (in the USA) only**

will be answered by Mercedes-Benz Client Assistance Representatives 24 hours a day, 365 days a year.

For additional information refer to the Mercedes-Benz Roadside Assistance Program brochure in your glove box.

### **Change of address or ownership**

If you change your address, be sure to send in the "Change of Address Notice" found in the Owner's Service and Warranty Policy Booklet. It is in your own interest that we can contact you should the need arise.

If you sell your Mercedes, please leave all owner's literature with the vehicle to make it available to the next owner.

If you bought this vehicle used, be sure to send in the "Notice of Purchase of Used Car" found in the Owner's Service and Warranty Policy Booklet.

### **Operating your vehicle outside the USA or Canada**

If you plan to operate your vehicle in foreign countries, please be aware that service facilities or replacement parts may not be readily available.

Certain Mercedes-Benz models are available for delivery in Europe under our European Delivery Program. For details, consult your authorized Mercedes-Benz dealer or write to:

In the USA:

Mercedes-Benz USA,  
LLC European Delivery Department  
One Mercedes Drive  
Montvale, NJ 07645

In Canada:

Mercedes-Benz Canada, Inc.  
European Delivery Department  
849 Eglinton Avenue East  
Toronto, Ontario M4G 2L5

We continuously strive to improve our product, and ask for your understanding that we reserve the right to make changes in design and equipment. Therefore, information, illustrations and descriptions in this Operator's Manual might differ from your vehicle.

Optional equipment is also described in this manual, including operating instructions wherever necessary. Since they are special-order items, the descriptions and illustrations herein may vary slightly from the actual equipment of your vehicle.

If there are any equipment details that are not shown or described in this Operator's Manual, your authorized Mercedes-Benz Center will be glad to inform you of correct care and operating procedures.

The Operator's Manual and Service Booklet are important documents and should be kept with the vehicle.

## **Check Regularly and Before a Long Trip**

See Index

### **The First 1000 Miles (1500 km)**

The more cautiously you treat your vehicle during the break-in period, the more satisfied you will be with its performance later on. Therefore, drive your vehicle during the first 1500 km (1000 miles) at moderate vehicle and engine-speeds. During this period, avoid heavy loads (full throttle driving) and high RPM (no more than 2/3 of maximum permissible speed in each gear as indicated on the speedometer).

Avoid accelerating by kickdown. It is not recommended to brake the vehicle by manually shifting to a lower gear. We recommend to select positions "3" or "2" only at moderate speeds (for hill driving).

After 1000 miles (1500 km) speeds may be gradually increased to the permissible maximum

### **Maintenance**

We strongly recommend that you have your vehicle serviced by your authorized Mercedes-Benz dealer, in accordance with the Maintenance Booklet.

Failure to have the vehicle maintained in accordance with the Maintenance Booklet may result in vehicle damage not covered by the Mercedes-Benz Limited Warranty.

### **Radio Transmitters**

#### **Warning!**

**Never operate radio transmitters equipped with a built-in or attached antenna (i.e. without the telephone connected to an external antenna) from inside the vehicle while the engine is running. Doing so could lead to a malfunction of the vehicle's electronic system, possibly resulting in an accident and personal injury.**

Radio transmitters, such as a portable telephone or a citizens band unit should only be used inside the passenger compartment, if they are connected to a Mercedes-Benz approved antenna that is installed on the outside of the vehicle.

<b>Introduction</b>					
<a href="#">Product information</a>	2	<a href="#">Doors</a>	33	<a href="#">Stowing Things in the Vehicle</a>	67
<a href="#">Operator's manual</a>	4	<a href="#">Central Locking Switch</a>	34	<a href="#">Ashtrays, Lighter</a>	68
<a href="#">Consumer Information</a>	145	<a href="#">Trunk</a>	35	<a href="#">Sliding roof with rear pop-up feature</a>	69
<a href="#">Problems with your vehicle</a>	146	<a href="#">Power Window and Sliding/Pop-Up Roof</a>	36	<a href="#">Power Windows</a>	70
<a href="#">Reporting Safety Defects</a>	147	<a href="#">Power Closing Ass. f Door and Trunk lid</a>	37	<a href="#">Rear Window Sunshade</a>	72
<a href="#">Index</a>	150	<a href="#">Anti-Theft Alarm System</a>	38	<a href="#">Trunk Lid Release switch</a>	72
		<a href="#">Power Seats, Front</a>	39	<a href="#">Shelf Below Rear Window</a>	72
<b>Instruments and controls</b>		<a href="#">Multicontour Backrest</a>	42	<a href="#">Instrument Lamps</a>	73
<a href="#">Instruments and controls</a>	10	<a href="#">Heated Seats</a>	43	<a href="#">Display Illumination</a>	73
<a href="#">Instrument Cluster</a>	12	<a href="#">Armrest, Front</a>	44	<a href="#">Trip Odometer</a>	73
<a href="#">Indicator Lamp Symbols</a>	13	<a href="#">Power Seats, Rear</a>	45	<a href="#">Clock</a>	73
<a href="#">Catalytic Converter</a>	15	<a href="#">Head Restraints, Rear</a>	46	<a href="#">Garage Door Opener</a>	74
<a href="#">Starting and Turning Off the Engine</a>	16	<a href="#">Armrest, Rear</a>	47	<a href="#">Antenna</a>	75
<a href="#">Driving Instructions</a>	17	<a href="#">Adjustable Steering Wheel</a>	47	<a href="#">Cellular telephone</a>	75
		<a href="#">Seat belts and Supplemental</a>			
<b>Operation</b>		<a href="#">Restraint system (SRS)</a>	48	<b>Driving</b>	
<a href="#">Automatic Climate Control</a>	22	<a href="#">Seat belts</a>	48	<a href="#">Drinking and driving</a>	78
<a href="#">Basic Setting – Automatic Mode</a>	24	<a href="#">Baby Smart Airbag</a>	48	<a href="#">Parking Brake</a>	78
<a href="#">Defogging Windows</a>	24	<a href="#">Deactivation System</a>	51	<a href="#">Driving off</a>	78
<a href="#">Defrosting, Rear Window Defroster</a>	24	<a href="#">Self Test</a>	52	<a href="#">Automatic Transmission</a>	79
<a href="#">Air circulation</a>	25	<a href="#">Emergency tensioning retractor (ETR)</a>	52	<a href="#">Cruise Control</a>	83
<a href="#">Activated Charcoal Control</a>	26	<a href="#">Airbag</a>	53	<a href="#">Parking Assist (Parktronic)</a>	85
<a href="#">Rear passenger compartment</a>	27	<a href="#">Child Restraint</a>	56	<a href="#">Charge Indicator Lamp</a>	88
<a href="#">Climate Control</a>	27	<a href="#">Steering lock</a>	58	<a href="#">Engine Oil Pressure Gauge</a>	88
<a href="#">Car keys</a>	28	<a href="#">Combination Switch</a>	59	<a href="#">Low Engine Oil Level Warning Lamp</a>	89
<a href="#">Start Lock-out</a>	29	<a href="#">Exterior Lamp Switch</a>	61	<a href="#">Engine Oil Consumption</a>	89
<a href="#">Central Locking System</a>	29	<a href="#">Night Security Illumination</a>	62	<a href="#">Fuel Consumption Gauge</a>	89
<a href="#">Radio Frequency Infrared Remote Control</a>	29	<a href="#">Inside Rear View Mirror</a>	62	<a href="#">Fuel Reserve and Fuel Cap</a>	89
		<a href="#">Exterior Rear View Mirror</a>	62	<a href="#">Placement Warning Lamp</a>	89
		<a href="#">Sun Visors, Vanity mirrors</a>	64	<a href="#">Outside Temperature Indicator</a>	90
		<a href="#">Interior Lighting</a>	65	<a href="#">Tachometer</a>	90
		<a href="#">Storage Compartments</a>	66		
		<a href="#">First Aid Kit</a>	67		



<a href="#">Coolant Temperature Gauge</a>	90	<a href="#">Automatic Trans. Fluid Level</a>	106	<b>Technical Data. Fuels,</b>	
<a href="#">Low Engine Coolant Level</a>		<a href="#">Spare Wheel</a>		<b>107 Coolants, Lubricants etc.</b>	
<a href="#">Warning Lamp</a>	91	<a href="#">Trunk Lamp</a>	107	<b>Consumer Information</b>	
<a href="#">Low Windshield and Headlamp</a>		<a href="#">Vehicle Jack</a>	108		
<a href="#">Washer Fluid Level Warning Lamp</a>	91	<a href="#">Vehicle Tools</a>	108	<a href="#">Identification Plates</a>	136
<a href="#">Exterior Lamp Failure</a>		<a href="#">Storage compartment below vehicle</a>		<a href="#">Vehicle Data Card</a>	137
<a href="#">Indicator Lamp</a>	92	<a href="#">tool box</a>	108	<a href="#">Warranty Coverage</a>	137
<a href="#">Seat Belt and Lock Warning Lamp</a>	92	<a href="#">Wheels</a>	109	<a href="#">Technical Data</a>	138
<a href="#">Brake Pad Wear Indicator Lamp</a>	92	<a href="#">Changing Wheels</a>	110	<a href="#">Fuels, Coolants, Lubricants etc.</a>	140
<a href="#">Brake Warning Lamp</a>	93	<a href="#">Tire Inflation Pressure</a>	113	<a href="#">Capacities</a>	140
<a href="#">Flexible Service System (FSS)</a>	93	<a href="#">Exterior Lamps</a>	114	<a href="#">Engine Oils</a>	142
<a href="#">ABS (Antilock Brake System)</a>	95	<a href="#">Battery</a>	120	<a href="#">Engine Oils Additives</a>	142
<a href="#">Brake Assist System (BAS)</a>	96	<a href="#">Fuses</a>	121	<a href="#">Air Conditioner Refrigerant</a>	142
<a href="#">Electronic Stability program (ESP)</a>	97	<a href="#">Jump Starting</a>	121	<a href="#">Brake Fluid</a>	142
<a href="#">Adaptive damping system (ADS)</a>	99	<a href="#">Towing the Vehicle</a>	123	<a href="#">Premium Unleaded Gasoline</a>	142
<a href="#">Emission Control</a>	100	<a href="#">Cleaning and Care of the Vehicle</a>	124	<a href="#">Fuel Requirements</a>	143
<a href="#">On-Board Diagnostic System</a>	100	<a href="#">Testing Infrared Remote Control</a>	128	<a href="#">Gasoline Additives</a>	143
<a href="#">Traveling Abroad</a>	101	<a href="#">Front Head Restraints</a>	129	<a href="#">Coolants</a>	144
<a href="#">Winter Driving</a>	101	<a href="#">Rear Bench Seat Cushion</a>	130	<a href="#">Service and Literature</a>	155
<a href="#">Snow Chains</a>	101	<a href="#">Emergency Operation of Sliding Roof</a>	130	<a href="#">Check Regularly Before a Long trip</a>	156
		<a href="#">Replacing Wiper Blades</a>	131		
		<a href="#">Manual Closing of Trunk Lid</a>	132		
		<a href="#">Manual Release of Fuel Filler Flap</a>	132		
		<a href="#">Roof Rack</a>	133		
	104	<a href="#">MERCEDES-BENZ</a>			
	105	<a href="#">Spare Part Service</a>	133		
	106	<a href="#">Layout of Poly-V-Belt Drive</a>	133		
<b>Practical Hints</b>					
<a href="#">Hood</a>					
<a href="#">Checking Coolant Level</a>					
<a href="#">Adding Coolant</a>					
<a href="#">Checking Engine Oil Level</a>					

**Instruments and Controls** *For more detailed descriptions see Index*

<b>1</b>	Left Front Parktronic warning indicator	<b>21</b>	Storage/eyeglasses compartment
<b>2</b>	Side air outlet, adjustable	<b>22</b>	Lock for storage/eyeglasses compartment and eye glove
<b>3</b>	Exterior lamp switch	<b>23</b>	Glove box (illuminated with key in steering lock position 1 or 2)
<b>4</b>	Parking brake release	<b>24</b>	Switch for rear seat head restraints
<b>5</b>	Hood lock release	<b>25</b>	Trunk lid release switch
<b>6</b>	Parking brake pedal	<b>26</b>	Central locking switch, Indicator for anti-theft alarm system
<b>7</b>	Steering wheel adjustment switch	<b>27</b>	Hazard warning flasher switch
<b>8</b>	Combination switch	<b>28</b>	Automatic climate control, Power window defroster switch Activated charcoal filter switch
<b>9</b>	Cruise control	<b>29</b>	Radio
<b>10</b>	Horn, airbag	<b>30</b>	ESP control switch
<b>11</b>	Instrument cluster	<b>31</b>	Ashtray with lighter
<b>12</b>	Steering lock with ignition/starter	<b>32</b>	Adaptive damping system adjustment switch
<b>13</b>	Right front Parktronic warning indicator	<b>33</b>	Seat heater switch
<b>14</b>	Center air outlet, adjustable	<b>34</b>	Mirror adjustment switch
<b>15</b>	Heated air supply button - center air outlet	<b>35</b>	Power window switch, front doors
<b>16</b>	Non heated/cooled air supply button - center air outlet	<b>36</b>	Power window safety switch, rear doors
<b>17</b>	Air volume control for left air outlet	<b>37</b>	Airbag Off indicator lamp
<b>18</b>	Air volume control for left center air outlet	<b>38</b>	Power window switches, rear doors
<b>19</b>	Air volume control for right center air outlet	<b>39</b>	Parktronic switch
<b>20</b>	Air volume control for right air outlet	<b>40</b>	Switch for rear window sunshade

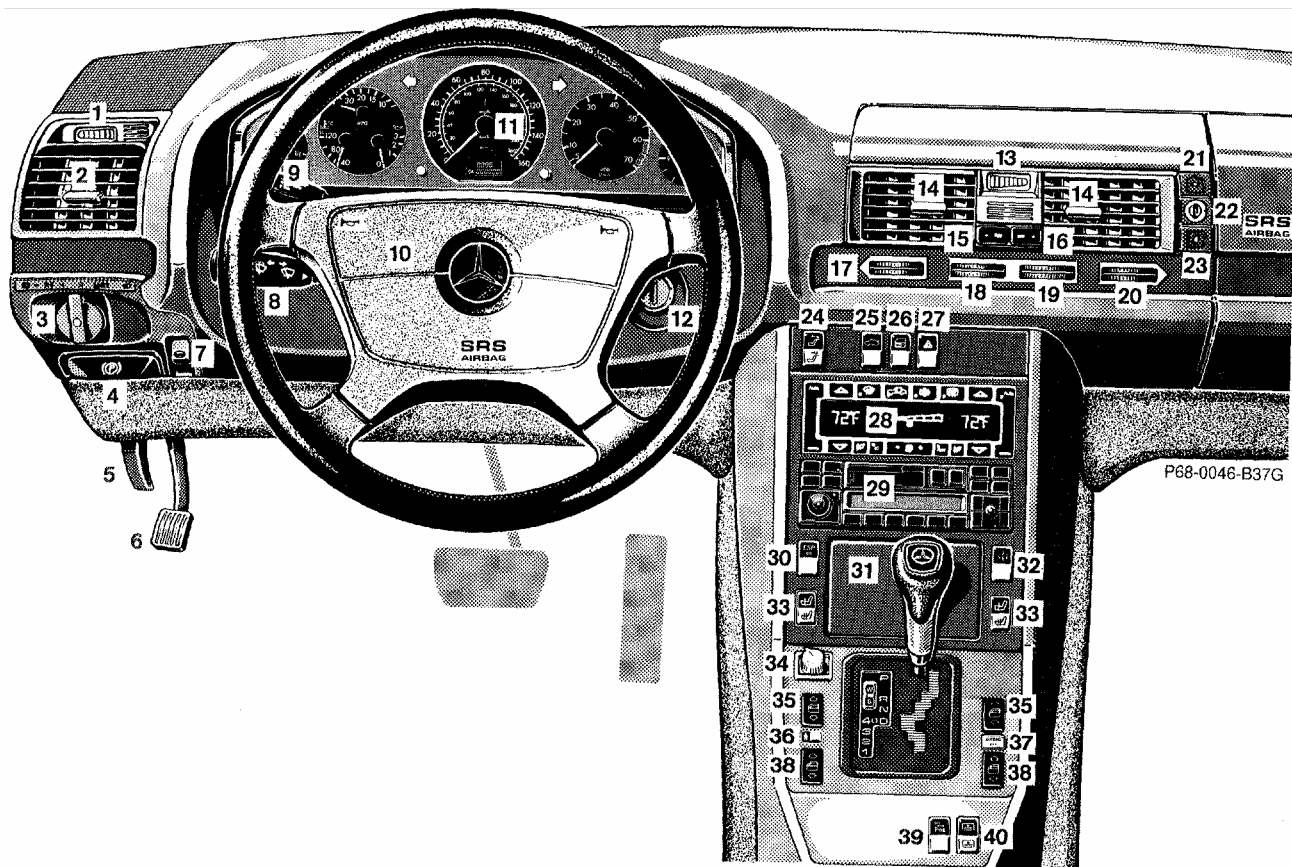

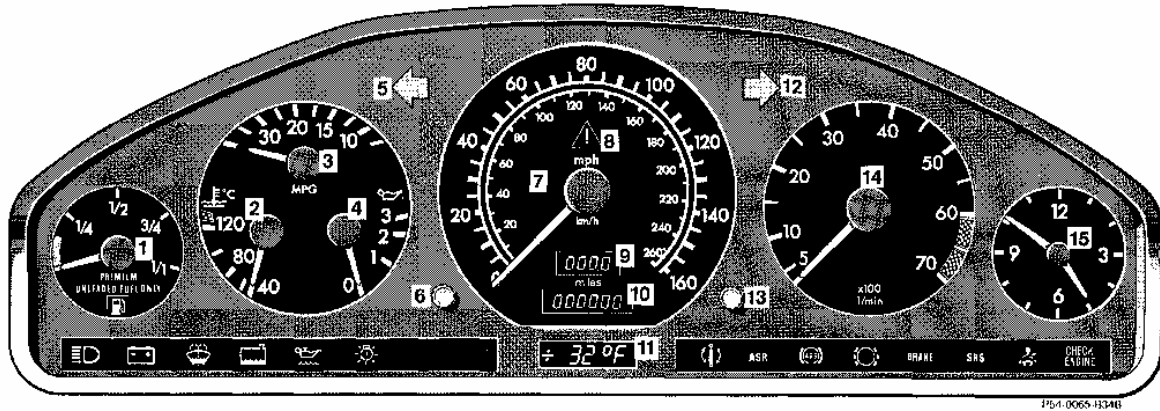

Pb4-0065-1334B

## Instrument Cluster

- |  |  |
|--|--|
| <p>1 Fuel gauge with reserve and fuel cap placement warning lamp (yellow). See Index</p> <p>2 Coolant temperature gauge. See Index</p> <p>3 Fuel consumption gauge. See Index</p> <p>4 Engine oil pressure gauge (bar). See Index</p> <p>5 Left turn signal indicator lamp (green). See Index</p> <p>6 Knob for instrument lamps and trip odometer. See Index</p> <p>7 Speedometer See Index</p> | <p>8 ESP function indicator lamp (yellow).</p> <p>9 Main/trip odometer. See Index</p> <p>10 Outside temperature indicator. See Index</p> <p>11 Right turn signal indicator lamp (green) See Index</p> <p>12 Knob for setting clock. See Index</p> <p>13 Tachometer. See Index</p> <p>14 Clock. See Index</p> |
|--|--|

## Indicator Lamp Symbols Function Indicator Lamp



High beam

### Warning Lamp

(should go out with the engine running unless)



ESP Adjust driving to road condition. See Index



Fluid level for windshield and headlamp washer system low. See Index.



Coolant level low. See Index.



Engine oil level low. See Index.



Brake pads worn down. See Index.



Brake fluid low (Canada only). Parking brake engaged. See Index.



Brake fluid low (except Canada). Parking brake engaged. See Index.



Fasten seat belts. See Index.



Battery not being charged properly. See Index



Exterior lamp failure. See Index.



ADS malfunction. See Index



BAS malfunction. See Index  
ESP malfunction. See Index



ABS malfunction. See Index



SRS malfunction. See Index



Engine malfunction. If the lamp comes on when the engine is running, it indicates a malfunction of the O2-sensor on Federal version vehicles, and fuel injection system or emission control system on the California version vehicles. In either case, we recommend that you have the malfunction checked as soon as possible. See Index.

### **Additional Function Indicator Lamps in the Odometer Display**



FSS indicator (distance). See Index



FSS indicator (days). See Index



Start Lock-Out malfunction. See Index.

### **Additional Function Indicator Lamp on the Center Console**



Passenger Airbag automatically switched off.  
See Index

## Catalytic Converter

Your MERCEDES-BENZ is equipped with monolithic type catalytic converters, an important element in conjunction with the O<sub>2</sub> sensor to achieve substantial control of the pollutants in the exhaust emissions. Keep your vehicle in proper operating condition by following our recommended maintenance instructions as outlined in your Maintenance Booklet.

## Caution!

To prevent damage to the catalytic converters, use only premium unleaded gasoline in this vehicle.

Any noticeable irregularities in engine operation should be repaired promptly. Otherwise, excessive unburned fuel may reach the catalytic converter causing it to overheat.

## Warning!

**As with any vehicle, do not idle, park or operate this vehicle in areas where combustible materials such as grass, hay or leaves can come into contact with the hot exhaust system, as these materials could be ignited and cause a vehicle fire.**

## **Starting and Turning off the Engine**

### **Before Starting**

Ensure that parking brake is engaged and that selector lever is in position "P" or "N". Turn key in steering lock to position 2. The charge indicator lamp should come on.

### **Starting**

Do not depress accelerator.

Turn key in steering lock clockwise to the stop. Release key only when the engine is firing regularly

### **Important!**

Due to the installed starter non-repeat feature, the key must be turned completely to the left before attempting to start the engine again.

Observe the oil pressure gauge immediately after starting the engine. In a very cold engine the oil pressure will rise slowly after the engine has started. Do not speed up the engine before pressure is registered on the pressure gauge. If you do not see the gauge register oil pressure, stop the engine and have it checked.

The charge indicator lamp should go out as soon as the engine has started.

In areas where temperatures frequently drop below -4°F (-20°C) we recommend that an engine block heater be installed. Your authorized Mercedes-Benz dealer will advise you on this subject.

### **Turning Off**

Turn the key in the steering lock to position 0 to stop the engine.

The key can only be removed with the foot off the brake pedal and the selector lever in position "P".



## Driving Instructions

### Warning!

**If you feel a sudden significant vibration or ride disturbance, or you suspect that possible damage to your vehicle has occurred, you should turn on the hazard flashers, carefully slow down, and drive with caution to an area which is a safe distance from the roadway.**

**Inspect the tires and under the vehicle for possible damage. If the vehicle or tires appear unsafe, have it towed to the nearest Mercedes-Benz or tire dealer for repairs.**

### Power Assistance

### Warning!

**When the engine is not running, the brake and steering systems are without power assistance. Under these circumstances, a much greater effort is necessary to stop or steer the vehicle.**

## Brakes

### Warning!

**After driving in heavy rain for some time without applying the brakes or through water deep enough to wet brake components, the first braking action may be somewhat reduced and increased pedal pressure may be necessary. Be sure to maintain a safe distance from vehicles in front.**

**Resting your foot on the brake pedal will cause excessive and premature wear of the brake pads.**

**It can also result in the brakes overheating thereby significantly reducing their effectiveness. It may not be possible to stop the car in sufficient time to avoid an accident.**

The condition of the parking brake system is checked each time the car is in the shop for the required maintenance.

If the parking brake is released and the brake warning lamp in the instrument cluster stays on, the brake fluid level in the reservoir is too low.

Brake pad wear or a leak in the system may be the reason for low brake fluid in the reservoir.

Have the brake system inspected at an authorized Mercedes-Benz dealer immediately.

All checks and maintenance work on the brake system should be carried out by an authorized MERCEDES-BENZ dealer.

Install only brake pads and brake fluid recommended by Mercedes-Benz.

### Warning!

**If other than recommended brake pads are installed, or other than recommended brake fluid is used, the braking properties of the vehicle can be degraded to an extent that safe braking is substantially impaired.**

### Caution!

When driving down long and steep grades, relieve the load on the brakes by shifting into "4", "3", "2" or "1". This helps prevent overheating of the brakes and reduces brake pad wear.

After hard braking, it is advisable to drive on for some time, rather than immediately parking, so the air stream will cool down the brakes faster.

### Tires

Tread wear indicators (TWI) are required by law. These indicators are located in six places on the tread circumference and become visible at a depth of approx. 2 mm (1/16 in), at which point the tire is considered worn and should be replaced.

The tread wear indicator appears as a solid band across the tread.

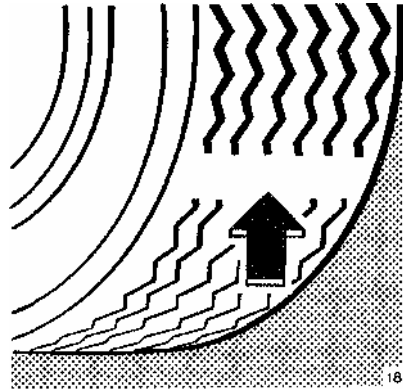

### Warning!

**Do not allow your tires to wear down too far. With less than 3 mm (1/8 in) of tread, the adhesion properties on a wet road are sharply reduced.**

**Depending upon the weather and/or road surface (conditions), the tire traction varies widely.**

Specified tire pressures must be maintained. This applies particularly if the tires are subjected to high loads (e.g. high speeds, heavy loads, high ambient temperatures).

### Warning!

**Do not drive with a flat tire. A flat tire affects the ability to steer or brake the vehicle. You may lose control of the car. Continued driving with a flat tire or driving at high speed with a flat tire will cause excessive heat build-up and possibly a fire, or tire blowout.**

### Aquaplaning

Depending on the depth of the water layer on the road, aquaplaning may occur, even at low speeds and with new tires. Avoid track grooves in the road and apply brakes cautiously in the rain.

## Tire Traction

The safe speed on a wet, snow covered or icy road is always lower than on a dry road.

You should pay particular attention to the condition of the road as soon as the prevailing temperatures fall close to the freezing point.

### Warning!

**If ice has formed on the road, tire traction will be substantially reduced. Under such weather conditions, drive, steer and brake with extreme caution.**

We recommend M + S radial-ply tires for the winter season for all four wheels to insure normal balanced handling characteristics.

On packed snow, they can reduce your stopping distance as compared with summer tires. Stopping distance, however, is still considerably greater than when the road is wet or dry.

## Tire Speed Rating

Your vehicle is factory equipped with "H" -rated tires, which have a European speed rating of 130 mph (210 km/h). An electronic speed limiter prevents your vehicle from exceeding the speed rating.

Despite the tire rating, local speed limits should be obeyed. Use prudent driving speeds appropriate to prevailing conditions.

### Warning!

**Even when permitted by law, never operate a vehicle at speeds greater than the maximum speed rating of the tires.**

**Exceeding the maximum speed for which tires are rated can lead to sudden tire failure causing loss of vehicle control and resulting in personal injury and possible death.**

## Parking

### Warning!

**To reduce the risk of personal injury as a result of vehicle movement, before turning off the engine and leaving the vehicle always:**

1. **Keep foot on brake pedal.**
2. **Firmly depress parking brake pedal.**
3. **Engage first or reverse gear (selector lever position "P" in the case of automatic transmissions).**
4. **Slowly release brake pedal.**
5. **Turn front wheels towards the road curb,**
6. **Turn the key to steering lock position 0 and remove.**
7. **Take your key and lock vehicle when leaving.**

### Important!

It is advisable to set the parking brake whenever parking or leaving the vehicle. In addition, engage first or reverse gear (selector lever position "P").

When parking on hills, always set the parking brake.

## Winter Driving Instructions

The most important rule for slippery or icy roads is to drive sensibly and to avoid abrupt acceleration, braking and steering action. Do not use the cruise control system under such conditions.

When the vehicle is in danger of skidding, declutch, or in case of automatic transmission move selector lever to position "N". Try to keep the vehicle under control by corrective steering action.

Road salts and chemicals can adversely affect braking efficiency. Increased pedal force may become necessary to produce the normal brake effect. We therefore recommend depressing the brake pedal repeatedly when traveling on salt-strewn roads at length. This can bring road salt impaired braking efficiency back to normal. A prerequisite is, however, that this is possible without endangering other drivers on the road.

If the vehicle is parked after being driven on salt treated roads, the braking efficiency should be tested as soon as possible after driving is resumed while observing the safety rules in the previous paragraph.

### Warning!

**If the vehicle becomes stuck in snow, make sure that snow is kept clear of the exhaust pipe and from around the vehicle with engine running. Otherwise, deadly carbon monoxide (CO) gases may enter vehicle interior resulting in unconsciousness and death.**

**To assure sufficient fresh air ventilation, open a window slightly on the side of the car that is out of the wind.**

## Deep Water

### Caution!

Do not drive through flooded areas or water of unknown depth.

If you must drive through deep water, drive slowly to prevent water from entering the engine compartment or being ingested by the air intake, possibly causing damage to electrical components or wiring, to engine or transmission that is not covered by the Mercedes-Benz Limited Warranty.

## Passenger Compartment

### Warning!

Always fasten items being carried as securely as possible.

**In an accident, during hard braking or sudden maneuvers, loose items will be thrown around inside the vehicle, and cause injury to vehicle occupants unless the items are securely fastened in the vehicle.**

**Operation**

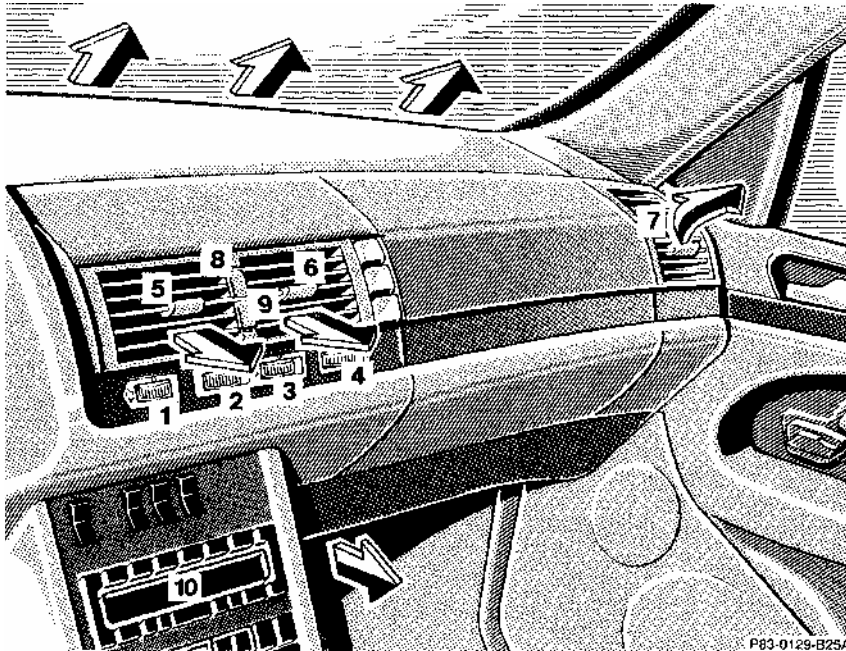

### Automatic Climate Control

The system is always at operational readiness, except when manually switched off.

The automatic climate control only operates with the engine running

The temperature selector should be left at the desired temperature setting. The temperature selected is reached as quickly as possible.

The system will not heat or cool any quicker by setting a higher or lower temperature.

- 1 Air volume control for left air outlet, turn left to open
- 2 Air volume control for left center air outlet, turn left to open
- 3 Air volume control for right center air outlet, turn left to open
- 4 Air volume control for right air outlet, turn left to open
- 5 Left center air outlet, adjustable
- 6 Right center air outlet, adjustable
- 7 Side air outlet, left and right, adjustable





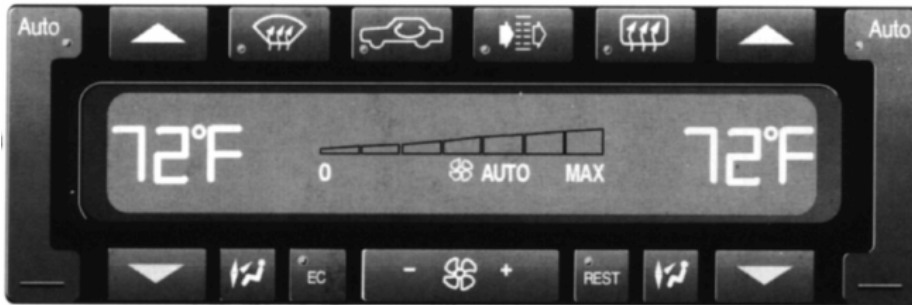





### Push-buttons for center air outlets

- 8 Heated air supply
- 9 Non-heated/cooled air supply  
Basic mode:  
None of the push-buttons (8 or 9) is pressed.
- 10 Display and Controls



### Display and Controls

Press to activate, indicator lamp is on while activated.

- |   |                   |   |                                  |
|---|-------------------|---|----------------------------------|
|  | Automatic mode    |  | Activated charcoal filter        |
|  | Raise temperature |  | Rear window defroster            |
|  | Lower temperature |  | Air distribution, manual         |
|  | Defrost           |  | Economy mode                     |
|  | Air recirculation |  | Air volume, manual               |
|   |                   |  | Residual engine heat utilization |

The automatic climate control removes considerable moisture from the air during operation in the cooling mode. It is normal for water to drip on the ground through ducts in the underbody.



The desired interior temperature can be selected separately for the left and right side of the passenger compartment.

### Important!

This vehicle is equipped with an air conditioner system that uses HFC-134a (ozone-friendly hydro-fluorocarbon) as a refrigerant. Repairs should always be performed by a qualified technician, and refrigerant should be collected in a recovery system for recycling.

## Basic Setting - Automatic Mode

Press left and right  for automatic mode.

Simultaneously press both  and  for temperature setting of 72°F.

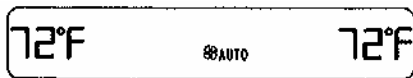

Air volume and distribution are controlled automatically.

This setting can be used all year around.

## Economy

The function of this setting corresponds to the automatic mode. However, because the air conditioning compressor will not engage (fuel savings), it is not possible to air condition in this setting.

Press  button to activate.

Press  button once again to return to previous setting.

## Special Settings (use only for short duration)

### Defogging Windows

Switch off  button.

Press left and right  buttons.

Press  button repeatedly until air is directed upward.

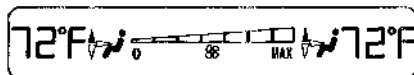



Turn wheels (1 and 4) left to open left and right air outlets (7). Adjust air outlets upward.

### Defrosting

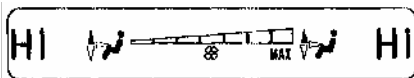
Turn wheels (1 and 4) left to open left and right air outlets (7). Adjust air outlets upward.



Press  button once again to return to previous setting.

Press  button. Maximum heated and automatically controlled amount of air is directed to the windshield and side windows.

## Rear Window Defroster

Turn key in steering lock to position 2.

To select, press  button.

To cancel, press  button again.

Note:

Heavy accumulation of snow and ice should be removed before activating the defroster.

The rear window defroster uses a large amount of power. To keep the battery drain to a minimum, turn off the defroster as soon as the window is clear.

The defroster is automatically turned off after a maximum of 12 minutes of operation.

If several power consumers are turned on simultaneously, or the battery is only partially charged, it is possible that the defroster will automatically turn itself off. When this happens, the indicator lamp inside the switch starts blinking.

As soon as the battery has sufficient voltage, the defroster automatically turns itself back on.



## Air Distribution



Press button repeatedly until the requested symbol is displayed.

## Air Volume

Press - or + side of rocker switch until requested blower speed is attained. A choice of 7 blower speeds is available.

To switch the automatic climate control off, press - side of rocker switch until symbol OFF is displayed.



The fresh air supply to the car interior is shut off.

While driving, use this setting only temporarily, otherwise the windshield could fog up.

To switch the automatic climate control on again, press , or +side of .

## Air Recirculation

This mode can be selected to prevent annoying odors or dust from entering the car's interior.

Outside air is not supplied to the car's interior.

To select, press button.

To cancel, press button again.

The system will automatically switch from recirculated air to fresh air

- after approx. 5 minutes at outside temperatures below approx. 40°F (5°C),
- after approx. 30 minutes, at outside temperatures above approx. 40°F (5°C),
- after approx. 5 minutes, if button is pressed.

Notes:

If the windows should fog up from the inside, switch from recirculated air back to fresh air.

At high outside temperatures, the system automatically engages the recirculated air mode thereby increasing the cooling capacity performance, switching to partially fresh air within 20 minutes.

## Dust Filter

Dust particles (down to a certain size) and pollen are filtered out before outside air enters the passenger compartment through the air distribution system.

Notes:

Do not obstruct the air flow by placing objects on the air flow-through exhaust slots below the rear window.

Also keep the air intake grille in front of windshield free of snow and debris.



## Activated Charcoal Filter

To select, press  button.  
To cancel, press  button again.

An activated charcoal filter markedly reduces bad odors and removes pollutants from the air entering the passenger compartment.

The blower speed is slightly increased to supply a constant volume of air.

The system switches automatically to the air recirculation mode, if the carbon monoxide (CO) or nitric oxide (NO<sub>x</sub>) of the outside air increases.

When pressing button  or  , the filter is also switched off.

## Notes:

The automatic air recirculation does not function when selecting the Economy mode , or the outside temperature is below 45°F (7°C).

The activated charcoal filter should be switched off when windows fog up on the inside, or if the passenger compartment needs to be quickly heated or cooled down.

## Residual Engine Heat Utilization

With the engine switched off, it is possible to continue heating the interior for a short while.

Air volume and distribution are controlled automatically.

To select:

Turn key in steering lock to position 1 or 0 or remove key. Close air outlet in rear passenger compartment.

Press  button.

This function selection will not activate if the battery charge level is insufficient.

To cancel:

Press  button.

The system will automatically shut off

- if you turn key in steering lock to position 2,
- after approx. 30 minutes,
- if the battery voltage drops.

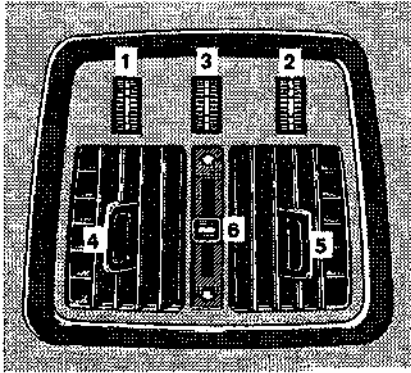

P83 0044 B13A

### Rear Passenger Compartment Climate Control

- 1 Temperature selector, left side
- 2 Temperature selector, right side

A basic setting in the white field of the selector is recommended.

- 3 Air volume selector

The air volume can be varied continuously. The air flow is switched off with selector in position "0".

- 4 Adjustable air outlet, left side

- 5 Adjustable air outlet, right side

- 6 Air distribution slide  
Top position: air flow from air outlets (4 and 5).

Bottom position: air flow from air outlets beneath front seats.

Intermediate positions can be selected for a mixed air flow.

Note:

The rear passenger climate control does not operate with automatic climate control in **EC** mode or switched off with the air volume control .

## Car Keys

Included with your vehicle are

- Master keys with infrared remote control
- 1 Master key
- 1 Valet key
- 1 Flat key

### Infrared Remote Control with Folding Master Key

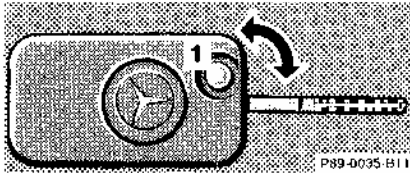

The master key fits all locks on the car. To release the key, press button (1). The key unfolds from the holder by itself.

The transmitter for the infrared remote control is located in the key holder the receivers are located in the driver's door handle, front passenger door handle, and next to the trunk lock.

The infrared receivers are located in the door front handles.

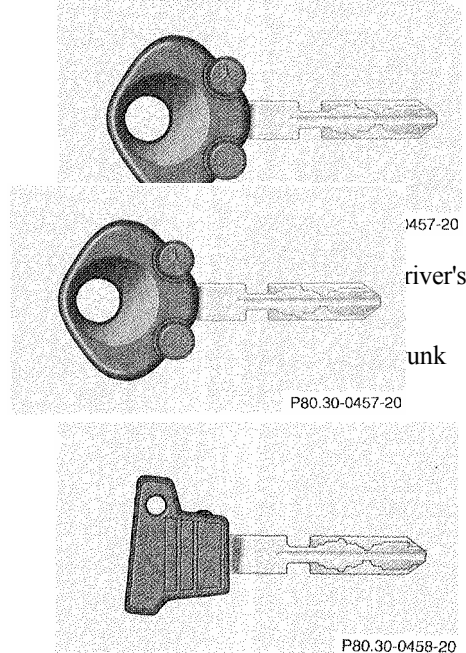

The flat key fits all locks on the Car.

Notes:

Do not give the master key to an unauthorized person.

We recommend that you carry the flat key with you and keep it in a safe place (e.g. your wallet) so that it is always handy. Never leave the flat key in the vehicle.

### Warning!

**When leaving the vehicle always remove the key from the steering lock. Do not leave children unattended in the vehicle. Unsupervised use of vehicle equipment may cause serious personal injury.**

### Obtaining Replacement Keys

Your vehicle is equipped with a theft deterrent locking system requiring a special key manufacturing process. For security reasons, replacement keys can only be obtained from your authorized Mercedes-Benz dealer.

## Starter Lock-Out

### Important!

Removing the key from the steering lock activates the start lock-out. The engine cannot be started.

Turning the key in the steering lock to position 2 deactivates the start lock-out.

Note:

In case the engine cannot be started, and the message START-ERROR shows in the odometer display field, the system is not operational. Contact an authorized Mercedes-Benz dealer or call 1-800-FOR-MERCEdes.

## Central Locking System

### Radio Frequency and Infrared Remote Control

The master key has an integrated radio frequency and infrared remote control. Due to the extended operational range of the remote control, it could be possible to unintentionally lock or unlock the vehicle by pressing the transmit button.

The vehicle doors, trunk and fuel filler flap can be centrally locked and unlocked.

Opening and closing the windows and sliding/pop-up roof can only be done with the infrared portion of the remote control. Aim transmitter eye (4) at a receiver (5 or 6) and press transmit button.

With vehicle centrally locked, the trunk can also be opened by using the remote control.

If the key is inserted in steering lock, the vehicle cannot be locked or unlocked with the remote control.

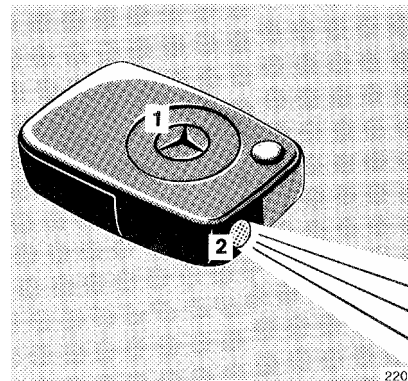

#### 1 Transmit button



Locking



Unlocking



Opening trunk  
(if not key locked)

#### 2 PANIC button

#### 3 Key release button

#### 4 Lamp for battery check and transmitter eye

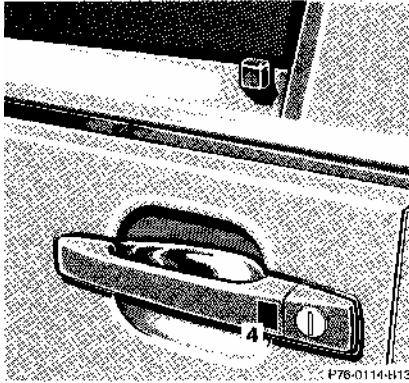

5 Infrared receiver in driver's door handle

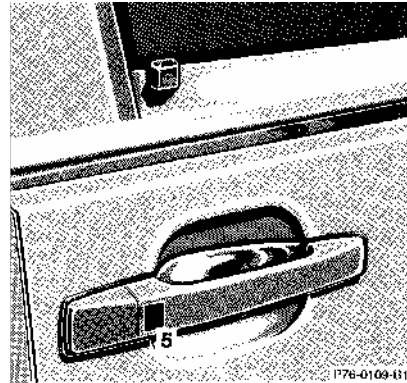



6 Infrared receiver in front passenger door handle

## Locking and Unlocking

Unlocking:

Press transmit button . All turn signal lamps blink once to indicate that the vehicle is unlocked.

The remote control can be programmed for two kinds of unlocking methods (see below):

Selective unlocking mode - Press transmit button  once to unlock driver's door and fuel filler flap. Press transmit button  twice to unlock doors, fuel filler flap, and trunk. Global unlocking mode-Press transmit button  once to unlock doors, fuel filler flap, and trunk.

Notes:

If the trunk was previously locked separately, it will remain locked (see Index).

The presently active unlocking mode (selective or global) can only be determined by unlocking the vehicle with the remote control (see below for changing mode).

The vehicle is automatically locked again, if within 40 seconds of unlocking with the remote control, neither door or trunk is opened, the key is not inserted in the steering lock, or the central locking switch is not activated.



Locking:

Press transmit button  once. All turn signal lamps blink three times to indicate that the vehicle is locked.

Note:

If the vehicle cannot be locked or unlocked by pressing the transmit button, then it may be necessary to change the batteries in the transmitter (if ok, battery check lamp in transmitter will light briefly when transmitting) or to synchronize the system, see *Remote Control* in Index.

### Choosing Global or Selective Mode on Remote Control

Press and hold transmit buttons  and  simultaneously for five seconds to reprogram the remote control. Battery check lamp will blink two times indicating the completed mode change.

### Opening the Trunk

A minimum height clearance of 5.9 ft. (1.8 m) is required to open the trunk lid.

Press transmit button  until trunk lid is released.

### Important!

Do not place remote control in trunk since trunk is locked again when closing the lid.

Note:

If the trunk was previously locked separately, it will remain locked (see Index).

## Opening and Closing Windows and Sliding/Pop-Up Roof from Outside

Aim transmitter eye (4) of remote control at door receivers (5 or 6).

To open:

Continue to press transmit button  after unlocking car.



The windows and sliding/pop-up roof begin to open after approx. 1 second. To interrupt opening procedure, release button.

To close:

Continue to press transmit button  after locking car.

The windows and sliding/pop-up roof begin to close after approx. 1 second. To interrupt closing procedure, release button.

## Warning!

**Never operate the windows or sliding/pop-up roof if there is the possibility of anyone being harmed by the opening or closing procedure. In case the procedure causes potential danger, the procedure can be immediately halted by releasing the remote control button. To reverse direction of movement press  for opening or  for closing.**

**The sliding/pop-up roof will only open if it was not fully closed.**

Note:

If the windows and sliding/pop-up roof cannot be operated automatically by pressing the transmit button of the remote control then it may be necessary to change the batteries in the transmitter (if ok, battery check lamp in transmitter will light briefly when transmitting), or to synchronize the system, see *Remote Control*, in Index.

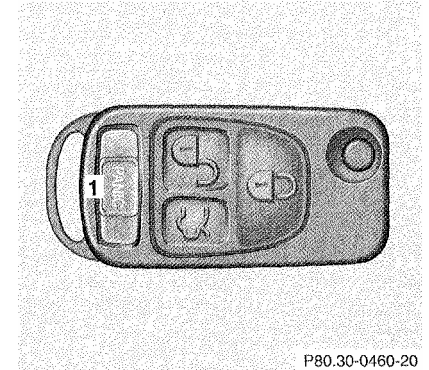

P80.30-0460-20

## Panic Button

To activate press and hold button (1) for at least one second. The alarm will last for approximately 3 minutes in form of blinking exterior lamps, and an additional horn will sound intermittently.

To deactivate press button (1) again, or turn key in steering lock to position 2.



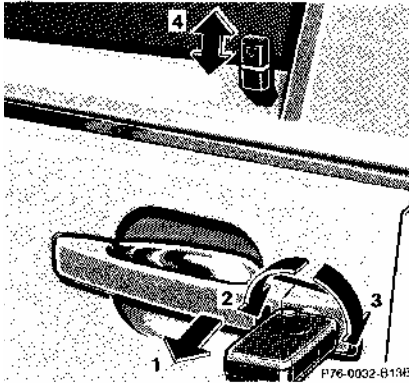

## Doors

The entire vehicle may be locked or unlocked by either using the master key in the door or trunk locks, or central locking switch located in center console. The central locking system also locks or unlocks the fuel filler flap.

Note:

If the fuel filler flap cannot be opened, refer to *Fuel Filler Flap, Manual Release* (see Index).

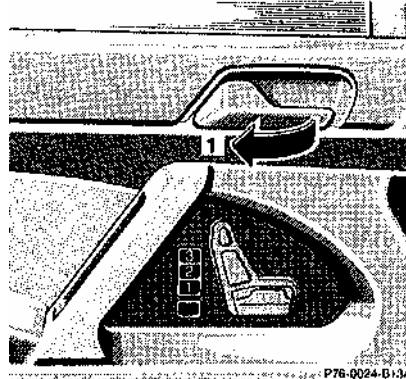

- 1 Opening - pull handle#
- 2 Unlocking
- 3 Locking
- 4 Individual door from inside:

- Push lock button down to lock.
- Pull lock button up to unlock.

When you lock the car, all door lock buttons should move down. If any one stays up, the respective door is not properly closed.

You should then unlock the car, open and reclose this door, and lock the car again. Each individual door can be locked with door lock button - the driver's door can only be locked when it is closed.

If the car has previously been locked from the outside, only the door being opened from the inside will unlock, and the alarm will come on. The remaining doors, the trunk lid and fuel filler flap remain locked.

Note:

In case of a malfunction in the central locking system the doors can be locked and unlocked individually.

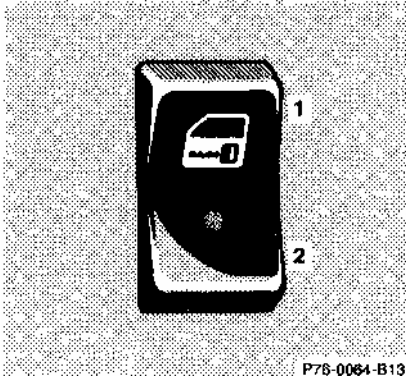

### Central locking switch

- 1 Locking
- 2 Unlocking

The central locking switch is located in the center console.

The doors and trunk can only be locked with the central locking switch, if the front doors are closed.

If the car was previously locked with the remote control or key, the doors and trunk cannot be unlocked with the central locking switch.

If the car was previously locked with the central locking switch, while in the selective remote control mode, only the door opened from the inside is unlocked.

If the car was previously locked with the central locking switch, while in the global remote control mode, the complete vehicle is unlocked when a front door is opened from the inside.

### Automatic Central Locking

The central locking switch also operates the automatic central locking.

To activate:

With key in steering lock position 2 hold upper portion of switch (1) for a minimum of 5 seconds.

To deactivate:

With key in steering lock position 2 hold lower portion of switch (2) for a minimum of 5 seconds.

With the automatic central locking system activated, the doors and trunk are locked at vehicle speeds of approx. 9 mph (15 km/h) or more. The fuel filler flap remains unlocked.

Notes:

If doors are unlocked with the central locking switch after activating the automatic central locking, and neither door is opened, then the doors remain unlocked even at vehicle speeds of approx. 9 mph (15 km/h) or more. Opening a door from the inside at speeds of approx. 9 mph (15 km/h) or less with the automatic central locking activated, the door will again be automatically locked at speeds of approx. 9 mph (15 km/h) or more.

### Emergency Unlocking in Case of Accident

The doors unlock automatically a short time after an accident (this is intended to aid rescue and exit). However, the key must still be in steering lock position 2.

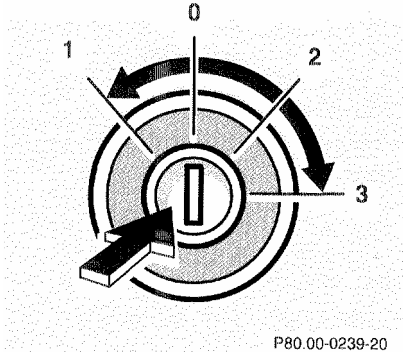

#### Notes:

In case of a malfunction in the central locking system the doors and trunk can be locked and unlocked individually.

If the fuel filler flap cannot be opened, refer to *Fuel Filler Flap, Manual Release* (see Index).

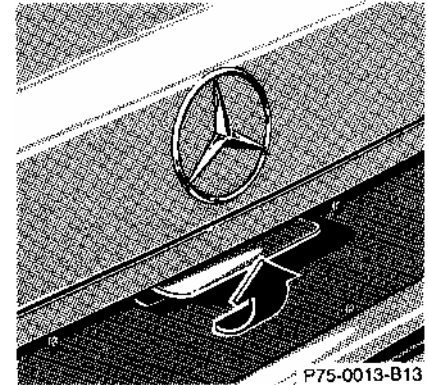

#### Trunk

- 0 Neutral position - push to open
- 1 Unlocking
- 2 Locking (detent)
- 3 Separate locking of trunk - remove key in this position.

When the trunk is separately locked, it remains locked when unlocking any door.

To deny any unauthorized person access to the trunk, lock it separately. Leave only the valet key with the vehicle.

The trunk lid can be lowered by using the recessed grips in the trunk lid liner, and closed with the dirt-free retracting handle.

If the trunk lid cannot be closed, refer to *Trunk Lid, Manual Closing* (see Index).

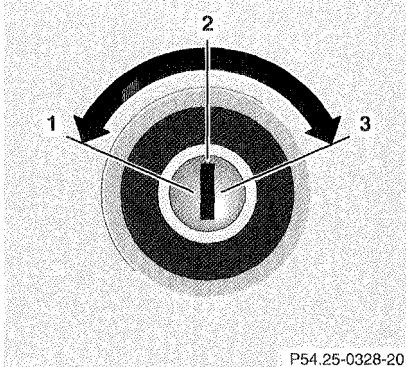

P54.25-0328-20

## Power Windows and Sliding/ Pop-Up Roof

- 1 Closing
- 2 Interrupting
- 3 Opening

When locking doors or trunk, turn key in door lock or trunk lock to position 3 and hold. The windows and the sliding/ pop-up roof begin to close automatically after approximately 2 seconds.

To interrupt the closing procedure, turn key to position 2.

When unlocking doors or trunk, turn key in door lock or trunk lock to position 1 and hold. The windows and the sliding/pop-up roof begin to open automatically after approximately 1 second.

To interrupt the opening procedure, turn key to position 2.

## Warning!

**Never operate the windows or sliding/ pop-up roof if there is the possibility of anyone being harmed by the procedure.**

**In case the procedure causes potential danger, the procedure can be immediately reversed by turning the key to the reversed operational direction within 10 seconds:**

- for opening position (1)
- for closing position (3).

**The sliding/pop-up roof will only open if it was not fully closed.**

Note:

If the opening/closing procedure is interrupted, it can only be continued by first turning the key to the interrupting position (2) and then again to the opening/closing position (1 or 3) and hold.

## **Power Closing Assist for Doors and Trunk Lid**

The doors and trunk lid close automatically if:

- doors are pushed against the lock,
- trunk lid is lowered against the lock.

It is not necessary to slam doors or trunk lid closed, a pneumatic power-assisted mechanism will latch doors and trunk lid quietly and automatically once the lid or door has been brought to a close. When the pneumatic power-assisted mechanism has stopped, doors and/or trunk can be reopened.

Note:

If the trunk lid does not close, refer to *Trunk Lid, Manual Closing* in Index.

## **Warning!**

**To prevent possible personal injury, always keep hands and fingers away from the door or trunk opening when closing a door or the trunk lid. Be especially careful when small children are around.**

**The pneumatic power closing assist mechanism cannot be interrupted once it has been engaged.**

**To prevent personal injury, never activate the closing assist mechanism by tampering with the door or trunk lid latch.**

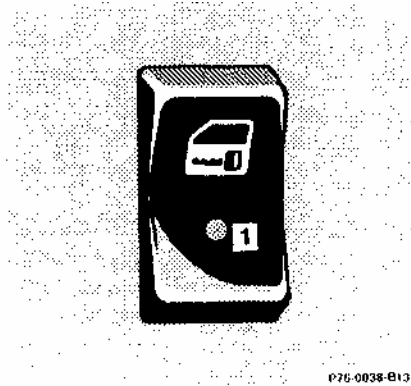

**1** Indicator lamp in switch located in center console

## Anti-Theft Alarm System

The anti-theft alarm is automatically armed or disarmed with any of your vehicle's keys or infrared remote control by locking or unlocking either front door or the trunk.

A blinking lamp (1) indicates that the alarm is armed.

The anti-theft alarm is disarmed when unlocking either front door or the trunk with any of your vehicle's keys or infrared remote control.

### Operation:

Once the alarm system has been armed, the exterior vehicle lamps will flash and the horn will sound intermittently when someone:

- opens a door,
- opens the trunk,
- opens the hood,
- switches on or bridges the ignition circuit,

The alarm will last approximately 150 seconds in the form of blinking exterior lamps. At the same time an alarm horn will sound intermittently for 60 seconds, pause for 30 seconds, and repeat for another 60 seconds. The alarm will stay on even if the activating element (a door, for example) is immediately closed.

### Note:

We recommend that you carry the flat key safely with you so that it is always handy. The flat key has the same functions as the master key.

## Power Seats, Front

### Warning!

**Do not adjust the driver's seat while driving. Adjusting the seat while driving could cause the driver to lose control of the vehicle.**

**Never ride in a moving vehicle with the seat back reclined. Sitting in an excessively reclined position can be dangerous. You could slide under the seat belt in a collision. If you side under it, the belt would apply force at the abdomen or neck. That could cause serious or even fatal injuries. The seat back and seat belts provide the best restraint when the wearer is in an upright position and belts are properly positioned on the body.**

**Never place hands under seat or near any moving parts while a seat is being adjusted.**

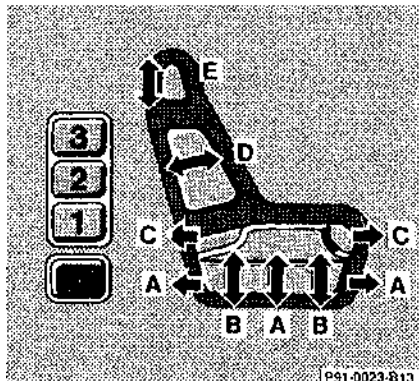

The slide switches are located in each front door.

### Warning!

**When leaving the vehicle always remove the key from the steering lock.**

**The power seats can also be operated with the driver's or front passenger door open. Do not leave children unattended in the vehicle. Unsupervised use of vehicle equipment may cause serious personal injury.**

Turn key in steering lock to position 1 or 2 (with the driver's or front passenger's door open, the power seats can also be operated with the key removed or in steering lock position 0).

Seat and head restraint adjustment:

A Seat, fore/aft, up/down

B Seat tilt

C Seat cushion depth

D Backrest tilt

E Head restraint Adjust head restraint to support the back of the head approximately at ear level. The head restraint inclination can also be adjusted manually.

Note:

Your car is equipped with power head restraints, do not try to raise or lower them manually.

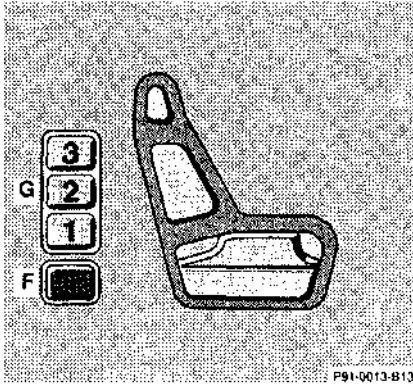

F Memory button

G Position buttons

Storing seat/head restraint/ steering wheel/exterior and inside rear view mirror positions in memory:

Three sets of seat/head restraint/ steering wheel/exterior and inside rear view mirror positions may be programmed into memory. After the seat/head restraint/steering wheel/ exterior and inside rear view mirrors are positioned, push memory button F, release, and within 3 seconds push position button "1". A second and third set of positions for the same seat/ head restraint/steering wheel/ exterior and inside rear view mirrors can be programmed into memory by pushing first button "F" and then "2", respectively "3".

Note:

See Index for instructions on adjustment of steering wheel and mirrors.

Recalling seat/head restraint/ steering wheel/exterior and inside rear view mirror positions stored in memory:

To recall a seat/head restraint/ steering wheel/exterior and inside rear view mirror position, push and hold position button "1", "2" or "3" until seat/head restraint/ steering wheel/exterior and inside rear view mirror movement has stopped. The seat/head restraint/ steering wheel/exterior and inside rear view mirror movement stops when the position button is released.

### Caution!

Do not remove head restraints except when mounting seat covers. For removal and installation refer to *Head Restraints, Removal* in Index. Whenever restraints have been removed be sure to reinstall them before driving.



## **Important!**

Bring seat backrest to upright position before recalling a stored seat/head restraint/steering wheel and exterior rear view mirror position, otherwise the front seats could get forced against a rear seat and be damaged.

Prior to operating the vehicle, the driver should adjust the seat height for proper vision as well as fore/aft placement and seat back angle to insure adequate control, reach, operation, and comfort. The head restraint should also be adjusted for proper height. See also airbag section for proper seat positioning.

Both the inside and outside rear view mirrors should be adjusted for adequate rearward vision.

Fasten seat belts. Infants and small children should be seated in a properly secured restraint system that complies with U.S. Federal Motor Vehicle Safety Standard 213 and Canadian Motor Vehicle Safety Standard 213.1.

All seat, head restraint, and rear view mirror adjustments as well as fastening of seat belts should be done before the vehicle is put into motion.

## **Warning!**

**Children 12 years old and under must never ride in the front seat, except in a Mercedes-Benz authorized BabySmart™ compatible child seat, which operates with the BabySmart™ system installed in the vehicle to deactivate the passenger side front airbag when it is properly installed. Otherwise they will be struck by the airbag when it inflates in a crash. If this happens, serious or fatal injury will result.**

**The back seat is the safest place for children. Infants and small children must ride in the back seats and be seated in an infant or child restraint system, which is properly secured with the vehicle's seat belt, fully in accordance with the seat manufacturer's instructions.**

**Children risk of serious or fatal injuries is significantly increased if the child restraints are not properly secured in the vehicle and they are not properly secured in the child restraint.**

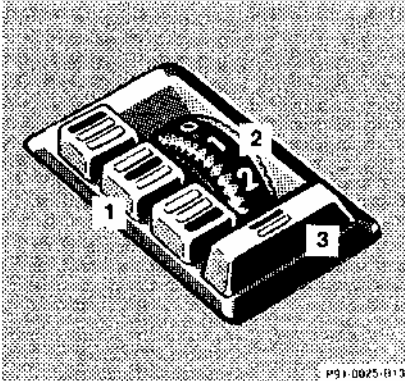

### **Multicontour Backrest**

- 1 Bottom
- 2 Center
- 3 Top
- 4 Pressure regulator
- 5 Side bolster adjustment

The seats have inflatable air cushions built into the backrest to provide additional lumbar and side support.

The amount of cushion height and curvature may be adjusted after turning the key in steering lock to position 2.

The center section (2) can be selected together with bottom section (1) or top section (3).

The inflation pressure of the air cushion can be continuously varied between position "0" = without pressure, and position "5" = maximum pressure, by changing the pressure regulator (4) setting.

The side bolsters of the backrest can be adjusted with push button (5):

- pushing forward - increase side support,
- pushing backward - decrease side support.

If the engine is turned off, the last cushion setting is retained in memory, and automatically adjusts the cushion to this setting when the engine is restarted.

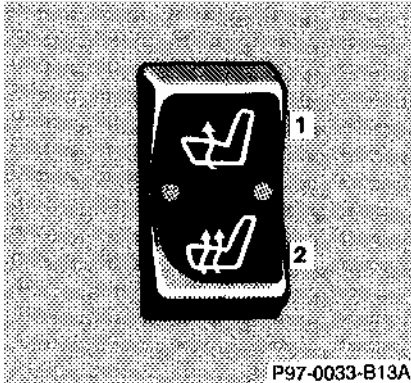

## Heated Seats

The front seat heater switches are located to the left and right side of the center console ashtray.

The rear seat heater switches are located in each rear door.

The front seat heaters can be switched on with the key in steering lock positions 1 or 2, the rear seat heaters only in steering lock position 2.

Press switch to turn on heater:

- 1 Normal heating mode. One indicator lamp in the switch lights up.
- 2 Rapid heating mode. Both indicator lamps in the switch light up.

After approximately 5 minutes in the rapid heating mode, the heater automatically switches to normal operation and only one indicator lamp will stay on.

Turning off heater:

If one indicator lamp is on, press upper half of switch.

If both indicator lamps are on, press lower half of switch.

If left on, the heater automatically turns off after approximately 30 minutes of operation.

Note:

When in operation, the seat heater consumes a large amount of power. It is advisable not to use the seat heater longer than necessary.

The seat heaters may automatically switch off if too many power consumers are switched on at the same time, or if the battery charge is low. When this occurs, the indicator lamp in the switch will blink (both indicator lamps blink during rapid seat heating). The seat heaters will switch on again automatically as soon as sufficient voltage is available.

If the blinking of the indicator lamps is distracting to you, the seat heaters can be switched off.

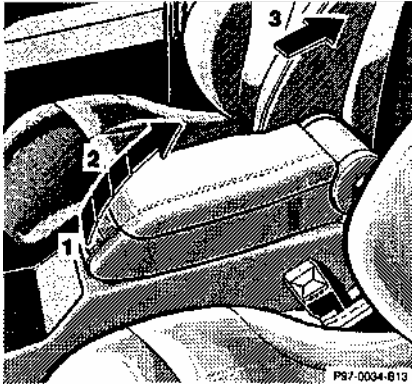

### Armrest with Compartments for Cup Holder and Telephone Handset (Front Seats)

- 1 Armrest folded down
- 2 Normal use  
(3 comfort positions)
- 3 Armrest folded up

Folding down:  
Raise armrest past top comfort position and push down.

Adjusting height:  
Raise armrest to desired position.

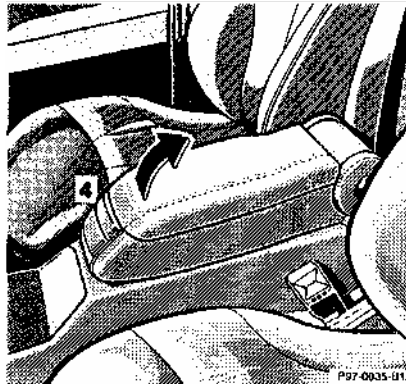

### Telephone Handset

Press button (4) to open cover.

### Cup Holder

Press button (5) to open cup holder.

To close cup holder, push button (6) down until cup holder engages. Close cover.

### Caution!

Keep compartment lids closed. This will prevent stored objects from being thrown about and injuring vehicle occupants during an accident.

### Warning!

The armrest does not suffice as a child restraint system. In case of a frontal collision a child can be catapulted forward over the locked armrest. Infants and small children should always be seated in a properly secured restraint system that complies with U.S. Federal Motor Vehicle Safety Standard 213 and Canadian Motor Vehicle Safety Standard 213.1.

## Power Seats, Rear

The seats can be adjusted using the slide switches located in either of the rear doors.

Turn key in steering lock to position 1 or 2 (with the driver's or front passenger's door open, the power seats can also be operated with the key removed or in steering lock position 0).

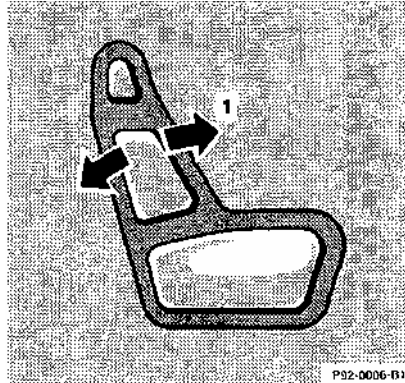

### Seat Bench

- 1 Backrest tilt

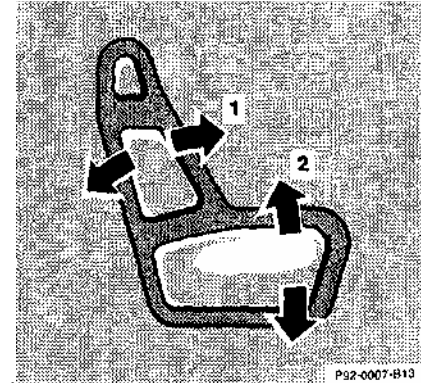

### Individual Seats

- 1 Backrest tilt  
The seat cushion moves fore/aft together with the inclination of the backrest.
- 2 Seat tilt

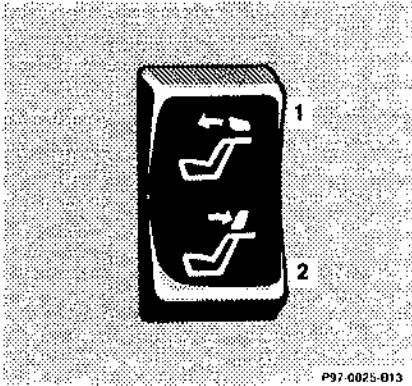

Switch on center console

### Power Head Restraints, Rear

Turn key in steering lock to position 1 or 2 (with the driver's or front passenger's door open, the power head restraints can also be operated with the key removed or in steering lock position 0).

Activate switch:

- 1 Place head restraint upright.
- 2 Fold head restraint backward.

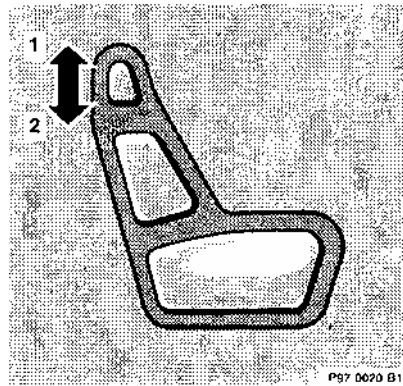

Switches in rear doors

Switch in center console:

Both head restraints together can be placed in either upright or fold-down position.

Switches in rear doors:

The head restraints can be placed individually in either upright or fold-down position.

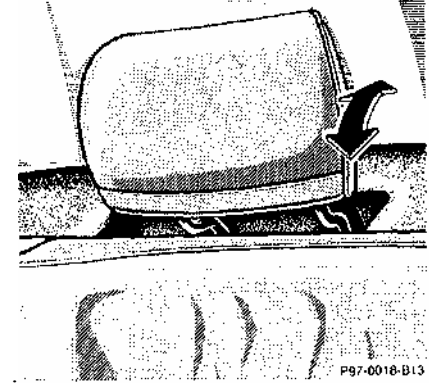

Angle of head restraints:

The head restraint inclination can be adjusted manually.

### Important!

For safety reasons, always drive with the rear head restraints in the upright position when the rear seats are occupied.

Keep area around head restraints clear of articles (e.g. clothing) to not obstruct the folding operation of the head restraints.

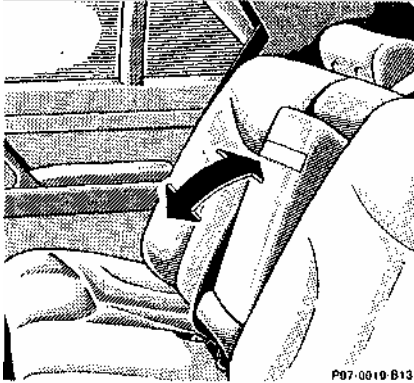

### **Armrest with Integrated Storage Compartment (Rear Bench Seat)**

Pull down the armrest by its strap.

Before storing the armrest in the backrest, close its storage compartment lid.

For the removal of the *Rear Seat Cushion*, see Index.

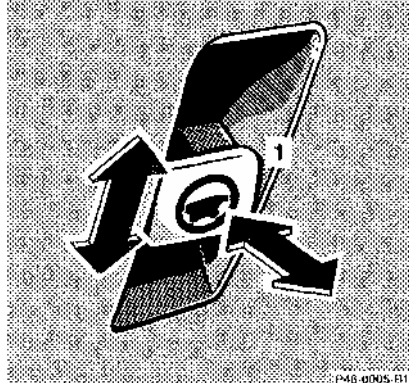

### **Adjustable Steering Wheel**

Turn key in steering lock to position 1 or 2 (with the driver's or front passenger's door open, the steering wheel can also be operated with the key removed or in steering lock position 0).

To lengthen or shorten the steering column, push in or pull out switch (1).

To raise or lower steering wheel, push switch (1) up or down.

Note:

The steering wheel position can be stored in memory together with the seat/head restraint/exterior and inside rear view mirror positions, see Index.

**Warning!**

**Do not adjust the steering wheel while driving. Adjusting the steering wheel while driving could cause the driver to lose control of the vehicle.**

## **Seat Belts and Supplemental Restraint System (SRS)**

Your vehicle is equipped with seat belts for all seats, emergency tensioning retractors for the front seats, as well as front and side impact airbags, and knee bolsters for driver and front passenger.  
Seat Belts

### **Important!**

Laws in most states and all Canadian provinces require seat belt use.

All states and provinces require use of child restraints that comply with U.S. Federal Motor Vehicle Safety Standard 213 and Canadian Motor Vehicle Safety Standard 213.1.

For your safety and that of your passengers we strongly recommend their use.

### **Warning!**

**Children 12 years old and under must never ride in the front seat, except in a Mercedes-Benz authorized BabySmart™ compatible child seat, which operates with the BabySmart™ system installed in the vehicle to deactivate the passenger side front airbag when it is properly installed. Otherwise they will be struck by the airbag when it inflates in a crash. If this happens, serious or fatal injury will result.**

**The back seat is the safest place for children. Infants and small children must ride in back seats and be seated in an infant or child restraint system, which is properly secured with the vehicle's seat belt, fully in accordance with the seat manufacturer's instructions.**

**Children risk of serious or fatal injuries is significantly increased if the child restraints are not properly secured in the vehicle and they are not properly secured in the child restraint.**

### **Warning!**

**Never ride in a moving vehicle with the seat back reclined. Sitting in an excessively reclined position can be dangerous. You could slide under the seat belt in a collision. If you slide under it, the belt would apply force at the abdomen or neck. That could cause serious or even fatal injuries. The seat back and seat belts provide the best restraint when the wearer is in an upright position and belts are properly positioned on the body.**



## Seat Belt Warning System

With the key in steering lock position 2, a warning sounds for a short time if the driver's seat belt is not fastened.

### Warning!

**Failure to wear and properly fasten and position your seat belt greatly increases your risk of injuries and their likely severity in an accident. You and your passengers should always wear seat belts.**

**If you are ever in an accident, your injuries can be considerably more severe without your seat belt properly buckled. Without your seat belt buckled, you are much more likely to hit the interior of the vehicle or be ejected from it. You can be seriously injured or killed.**

**In the same crash, the possibility for injury or death is lessened with your seat belt buckled.**



- 1 Latch plate
- 2 Buckle
- 3 Release button

### Fastening of Seat Belts

Push latch plate (1) into buckle (2) until it clicks.

The lap belt should be positioned as low as possible on your hips and not across the abdomen.

Three-point seat belt:

Tighten the lap portion to a snug fit by pulling shoulder portion up.

Rear center seat belt: Tighten to a snug fit by feeding belt toward retractor.

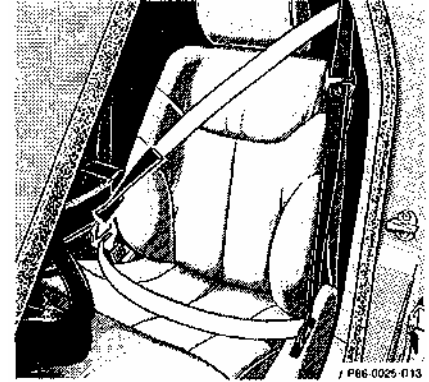

Adjust seat belt so that shoulder portion is located as close as possible to the middle of your shoulder. Do not twist the belt.

The shoulder portion of the seat belt must be pulled snug and checked for snugness immediately after engaging it. The height setting for the shoulder portion of the front seat belts are automatically adjusted by the fore/ aft movement of the front seat.

Seat moved to front: Belt outlet fully lowered.

Seat moved to rear: Belt outlet fully raised.

For safety reasons, avoid adjusting the seat or seat back into positions which could affect the correct seat belt position.

### Unfastening of Seat Belts

Push the release button (3) in the belt buckle (2).

Allow the retractor to completely rewind the seat belt by guiding the latch plate (1).

Notes:

The rear seat belt buckles can be stored in the space next to the rear armrest (to the left and right of armrest). The rear center seat belt should be latched and stored under the armrest.

For cleaning and care of the seat belts, see *Cleaning and Care of the Vehicle* in Index.

Operation:

The inertia reel stops the belt from unwinding during sudden vehicle stops or when quickly pulling on the belt. The locking function of the reel may be checked by quickly pulling out the belt.

### USE SEAT BELTS PROPERLY.

#### Warning!

- **Each occupant should wear their seat belt at all times, because seat belts help reduce the likelihood of and potential severity of injuries in accidents, including rollovers. "SRS" (driver airbag, passenger airbag), "ETR" (seat belt emergency tensioning retractors), and knee bolsters are designed to enhance the protection offered to properly belted occupants in certain frontal impacts which exceed preset deployment thresholds.**
  - **Improperly positioned seat belts do not provide maximum protection and may cause serious injuries in case of an accident.**
  - **Never wear the shoulder belt under your arm, against your neck or off your shoulder. In a crash, your body would move too far forward. That would increase the chance of head and neck injuries. The belt would also**
- apply too much force to the ribs or abdomen, which could severely injure internal organs such as your liver or spleen.**
- **Position the lap belt as low as possible on your hips and not across the abdomen. If the belt is positioned across your abdomen, it could cause serious injuries in a crash.**
  - **Each seat belt should never be used for more than one person at a time. Do not fasten a seat belt around a person and objects.**
  - **Belts should not be worn twisted. In a crash, you wouldn't have the full width of the belt to take impact forces. The twisted belt against your body could cause injuries.**
  - **Pregnant women should also use a lap-shoulder belt. The lap belt portion should be positioned as low as possible on the hips to avoid any possible pressure on the abdomen.**

**Warning!**

**USE CHILD RESTRAINTS PROPERLY.**

Children 12 years old and under must never ride in the front seat, except in a Mercedes-Benz authorized BabySmart™ compatible child seat, which operates with the BabySmart™ system installed in the vehicle to deactivate the passenger side front airbag when it is properly installed. Otherwise they will be struck by the airbag when it inflates in a crash. If this happens, serious or fatal injury will result.

The back seat is the safest place for children. Infants and small children must ride in back seats and be seated in an infant or child restraint system, which is properly secured with the vehicle's seat belt, fully in accordance with the seat manufacturer's instructions.

Children risk of serious or fatal injuries is significantly increased if the child restraints are not properly secured in the vehicle and they are not

- **Children too big for child restraint systems should ride in rear seats using regular seat belts. Position shoulder belt across chest and shoulder, not face or neck. A booster seat may be necessary to achieve proper belt positioning.**

**BabySmart™ Airbag Deactivation System**

Special child seats, designed for use with the Mercedes-Benz system and available at any authorized Mercedes-Benz dealer are required for use with the BabySmart™ airbag deactivation system.

With the special child seat properly installed, the passenger front airbag will not deploy. The  indicator lamp located on the center console will be illuminated, except with key removed or in steering lock position 0. The system does not deactivate the door mounted side impact airbag.

BabySmart™ is a trademark of Siemens Automotive Corp.

**Warning!**

The BabySmart™ Airbag Deactivation System will **ONLY** work with a special seat designed to operate with it. It will not work with seats which are not BabySmart™ compatible. Never place anything between seat cushion and child seat (e.g. pillow), since it reduces the effectiveness of the deactivation system. Follow the manufacturer's instructions for installation of special child seats. The passenger front airbag will not deploy only if the  indicator lamp remains illuminated.

Please be sure to check the indicator every time you use the special system child seat. Should the light go out while the restraint is installed, Please check installation. If the light remains out, do not use the BabySmart™ restraint to transport children, or other wise - do not transport child restraints on the front passenger seat until the system has been repaired.

## Self-Test BabySmart™ Without Special Child Seat installed

After turning key in steering lock to position 1 or 2, the  indicator lamp located on center console comes on for approx. 6 seconds.

If the lamp should not come on or is continuously lit, the system is not functioning. You must see an authorized Mercedes-Benz dealer before using any child seat.

BabySmart™ is a trademark of Siemens Automotive Corp.

**Supplemental Restraint System (SRS)**  
The term Supplemental Restraint System means that airbags are intended as a supplement to seat belts. Airbags alone cannot protect as well as airbags plus seat belts in impacts for which the airbags were designed to operate, and do not afford any protection whatsoever in crashes for which the system is not designed to deploy.

The SRS uses two crash severity levels (thresholds) to activate either the ETR or airbag or both. Activation depends on the direction and severity of the impact, exceeding the thresholds and fastening of the seat belt.

### Seat belt fastened

- first threshold exceeded: ETR activates
- second threshold exceeded: airbag also activates

### Seat belt not fastened

- first threshold exceeded: airbag activates, but not ETR

Driver and front passenger systems operate independently from each other.

## Emergency Tensioning Retractor (ETR)

The seat belts for the front seats are equipped with emergency tensioning retractors. These tensioning retractors are located in each belt's inertia reel and become operationally ready with the key in steering lock position 1 or 2.

The emergency tensioning retractors are designed to activate only when the seat belts are fastened during frontal and front-angled impacts exceeding the first threshold of the SRS. They remove slack from the belts in such a way that the seat belts fit more snugly against the body restricting its forward movement as much as possible.

In cases of other frontal impacts, roll-overs, certain side impacts, rear collisions, or other accidents without frontal forces, the emergency tensioning retractors will not be activated. The driver and passengers will then be protected by the fastened seat belts and inertia reel in the usual manner.

For seat belt and emergency tensioning retractor safety guidelines see *Safety Guidelines* in Index.

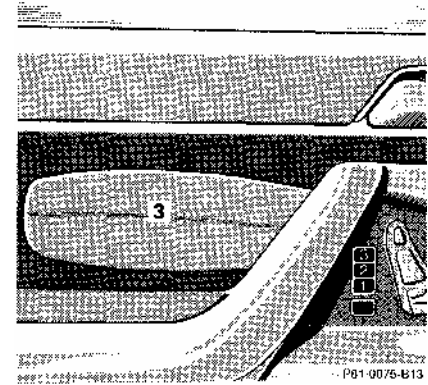
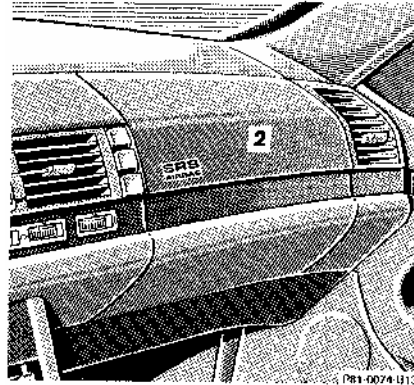
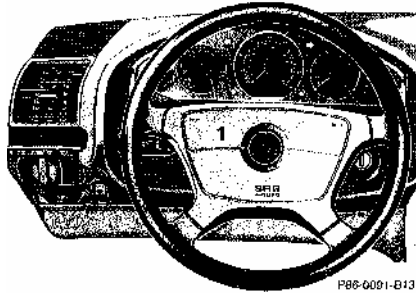

## Airbags

- 1 Driver airbag
- 2 Front passenger airbag
- 3 Side impact airbag

The most effective occupant restraint system yet developed for use in production vehicles is the seat belt. In some cases, however, the protective effect of a seat belt can be further enhanced by an airbag.

The driver airbag is located in the steering wheel hub. The passenger airbag is located in the dashboard ahead of the passenger

The side impact airbags are located in the front doors. In conjunction with wearing the seat belts with emergency tensioning retractors, the airbags can provide increased protection for the driver and passenger in certain major frontal (for front airbags) and side impacts (for side impact airbags).

The operational readiness of the airbag system is verified by the indicator lamp "SRS" in the instrument cluster. If no fault is detected, the lamp will go out after approximately 4 seconds; after the lamp goes out, the system continues to monitor the components and

circuitry of the airbag system and will indicate a malfunction by coming on again.

The following system components are monitored or undergo a self-check: crash-sensor(s), airbag ignition circuits, front seat belt buckles, emergency tensioning retractors, seat sensor (when present).

Initially, when the key is turned from steering lock position 0 to positions 1 or 2, malfunctions in the crash-sensor are detected and indicated (the "SRS" indicator lamp stays on longer than 4 seconds).

In the operational mode, after the

indicator lamp has gone out following the initial check, interruptions and short circuits in the airbag ignition circuit and in the driver and passenger seat belt buckle harnesses, and low voltage in the entire system are detected and indicated.

### **Warning!**

**In the event a malfunction of the "SRS" is indicated as outlined above, the "SRS" may not be operational. For your safety, we strongly recommend that you visit an authorized Mercedes-Benz dealer immediately to have the system checked; otherwise the "SRS" may not be activated when needed in an accident, which could result in serious or fatal injury, or it might deploy unexpectedly and unnecessarily which could also result in injury.**

### **Front Airbags**

The driver and passenger front "SRS" airbags are designed to activate only in certain frontal impacts. The passenger front airbag deploys only if the passenger seat is occupied.

Note:

Heavy objects on passenger seat can cause the front airbag to deploy in a crash.

### **Side Impact Airbags**

The side impact "SRS" airbags are designed to activate only in certain side impacts. Only the side airbag on the impacted side of the vehicle deploys. The side impact airbag for the front passenger deploys only if the seat is occupied.

Side impact airbags operate best in conjunction with a properly positioned and fastened seat belt.

Note:

Heavy objects on passenger seat can cause the side impact airbag to deploy in a crash.

### **Important!**

**The "SRS" airbags are designed to activate only in certain frontal or side impacts. Only during these types of impacts, if of**

**sufficient severity to meet the deployment thresholds, will they provide their supplemental protection. The driver and passenger should always wear the seat belts, otherwise it is not possible for the airbags to provide their intended supplemental protection.**

**In cases of other frontal impacts, roll-overs, other side impacts, rear collisions, or other accidents without sufficient forces, the airbag will not be activated. The driver and passengers will then be protected by the fastened seat belts.**

**We caution you not to rely on the presence of an airbag in order to avoid wearing your seat belt.**

**The "SRS" is designed to reduce the potential of injury in certain frontal, front-angled and side impacts which may cause injuries, however, no system available today can totally eliminate injuries and fatalities.**

**The activation of the "SRS" temporarily releases a small amount of dust from the airbags.**

**This dust, however, is neither injurious to your health, nor does it indicate a fire in the vehicle.**

**The service life of the airbags extends to the date indicated on the label located on the driver-side door latch post. To provide continued reliability after that date, they should be inspected by an authorized Mercedes-Benz dealer at that time and replaced when necessary.**

### **Warning!**

**It is very important for your safety to always be in a properly seated position and to wear your seat belt.**

**For maximum protection in the event of a collision always be in normal seated position with your back against the seat back. Fasten your seat belt and ensure that it is properly positioned on the body.**

**Since the airbag inflates with considerable speed and force, a proper seating and hands on steering wheel position will help to keep you in a safe distance from the airbag:**

- **Sit properly belted in an upright position with your back against the seat back.**
- **Adjust the driver seat as far as possible rearward, still permitting proper operation of vehicle controls.**
- **Do not lean with your head or chest close to the steering wheel or dashboard.**
- **Keep hands on the outside of steering wheel rim. Placing hands and arms inside the rim can increase the risk and potential severity of hand/arm injury when airbag inflates.**

- **Adjust the front passenger seat rearward as far as possible from the dashboard when the seat is occupied.**
- **Children 12 years old and under must never ride in the front seat, except in a Mercedes-Benz authorized BabySmart™ compatible child seat, which operates with the BabySmart™ system installed in the vehicle to deactivate the passenger side front airbag when it is properly installed. Otherwise they will be struck by the airbag when it inflates in a crash. If this happens, serious or fatal injury will result.**

**Failure to follow these instructions can result in severe injuries to you or other occupants.**

## Safety Guidelines for the Seat Belt, Emergency Tensioning Retractor and Airbag

### Warning!

- **Damaged belts or belts that were highly stressed in an accident must be replaced and their anchoring points must also be checked. Use only belts installed or supplied by an authorized Mercedes-Benz dealer.**
- **Do not pass belts over sharp edges.**
- **Do not make any modification that could change the effectiveness of the belts.**
- **The "SRS" is designed to function on a one-time-only basis. An airbag or emergency tensioning retractor (ETR) that was activated must be replaced.**
- **No modifications of any kind may be made to any**

**components or wiring of the "SRS". This includes the installation of additional trim material, badges etc. over the steering wheel hub or front passenger airbag cover and installation of additional electrical/electronic equipment on or near "SRS" components and wiring.**

- **An airbag system component within the steering wheel gets hot after the airbag has inflated.**
- **Improper work on the system, including incorrect installation and removal, can lead to possible injury through an uncontrolled activation of the "SRS".**
- **In addition, through improper work there is the risk of rendering the "SRS" inoperative. Work on the "SRS" must therefore only be performed by an authorized Mercedes-Benz dealer.**

- **When scrapping the airbag unit or emergency tensioning retractor, it is mandatory to follow our safety instructions. These instructions are available at your authorized Mercedes-Benz dealer.**

When you sell the vehicle we strongly urge you to give notice to the subsequent owner that it is equipped with an "SRS" by alerting him to the applicable section in the Owner's Manual.

### Infant and Child Restraint Systems

We recommend that all infants and children be properly restrained at all times while the vehicle is in motion.

All seats except driver seat have special seat belt retractors for secure fastening of child restraints. To use, fasten child restraint with seat belt:

Follow child restraint instructions for routing. Then pull belt out completely and let it retract. The belt is now locked. Push down on child restraint to take up any slack.



## **Important!**

The use of infant or child restraints is required by law in all 50 states and all Canadian provinces.

Infants and small children should be seated in an infant or child restraint system properly secured by a lap shoulder belt, and that complies with U.S. Federal Motor Vehicle Safety Standard 213 and Canadian Motor Vehicle Safety Standard 213.1. A statement by the child restraint manufacturer of compliance with this standard can be found on the instruction label on the restraint and in the instruction manual provided with the restraint.

When using any infant or child restraint system, be sure to carefully read and follow all manufacturer's instructions for installation and use.

Please read and observe warning labels affixed to inside of vehicle.

## **Warning!**

**Children 12 years old and under must never ride in the front seat, except in a Mercedes-Benz authorized**

**BabySmart™ compatible child seat, which operates with the BabySmart™ system installed in the vehicle to deactivate the passenger side front airbag when it is properly installed. Otherwise they will be struck by the airbag when it inflates in a crash. If this happens, serious or fatal injury will result.**

**The back seat is the safest place for children. Infants and small children must ride in back seats and be seated in an infant or child restraint system, which is properly secured with the vehicle's seat belt, fully in accordance with the seat manufacturer's instructions.**

**Infants and small children should never share a seat belt with another occupant. During an accident, they could be crushed between the occupant and seat belt.**

**Children too big for child restraint systems must ride in back seats using regular seat belts. Position shoulder belt across chest and shoulder, not face or neck. A booster seat is**

**necessary to achieve proper belt positioning for children from 41 lbs. to the point where a lap/shoulder belt fits properly without one.**

**When the child restraint is not in use, remove it from the car or secure it with the seat belt to prevent the child restraint from becoming a projectile in the event of an accident.**

U.S.A. Models only:

Since 1986 all U.S. child restraints comply with U.S. regulations without the use of a tether strap.

Canada Models only:

This vehicle is provided with tether anchorages for a top tether strap. Consult your authorized Mercedes-Benz dealer for installation of these anchorages.

In compliance with Canadian Motor Vehicle Safety Standard 210.1, child restraint tether anchorage hardware is attached to the tool kit located in the trunk.

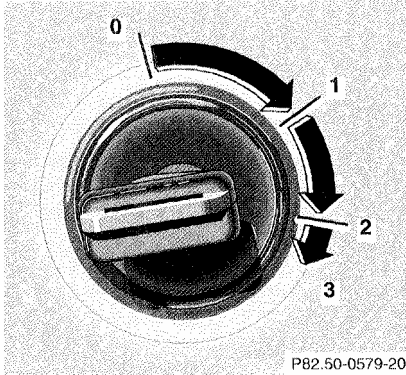

P82.50-0579-20

## Steering Lock

- 0 The key can be withdrawn in this position only. The steering is locked with the key removed from the steering lock. The key can be removed only with the selector lever in position "P". After removing the key or with the key in steering lock position 0, the selector lever is locked in position "P".

- 1 Steering is unlocked.  
(If necessary, move steering wheel slightly to allow the key to be turned clockwise to position 1.)  
Most electrical consumers can be operated. For detailed information see respective subjects.

- 2 Driving position.

- 3 Starting position.

Refer to Index for *Starting and turning off the engine*.

## Warning!

**When leaving the vehicle always remove the key from the steering lock. Do not leave children unattended in the vehicle. Unsupervised use of vehicle equipment may cause serious personal injury.**

## Notes:

A warning sounds when the driver's door is opened with the key in steering lock position 1 or 0.

With the engine at idle speed, the charging rate of the alternator (output) is limited.

It is therefore recommended to turn off unnecessary electrical consumers while driving in stop-and-go traffic. This precaution helps to avoid draining of the battery.



Unnecessary strain on the battery and charging system may be minimized by turning off the following power consumers, for example: Heated seats, rear window defroster. In addition, the automatic climate air volume control should be set to "MIN".

## Caution!

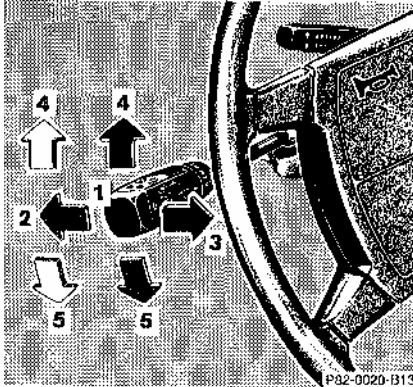

To prevent accelerated battery discharge and a possible dead battery, always remove the key from the steering lock. **Do not** leave the key in steering lock position 0.

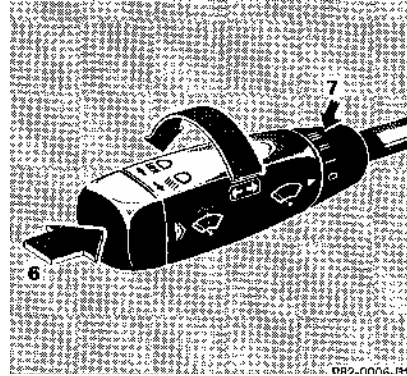

### Combination Switch

- 1 Low beam (exterior lamp switch position )
- 2 High beam (exterior lamp switch position )
- 3 High beam flasher (high beam available independent of exterior lamp switch position)
- 4 Turn signals, right
- 5 Turn signals, left



- 6 Press switch briefly:  
One wipe without washer water (select only if window is wet) Press switch past resistance point:  
Windshield washer, windshield wiper; headlamp cleaning system (only in exterior lamp switch positions  or  Canada only; also in position when the engine is running)

- 7 Windshield wiper
  - 0 Wiper off
  - I Intermittent wiping
  - II Normal wiper speed
  - III Fast wiper speed

Note:

The windshield washer reservoir, hoses and nozzles are automatically heated.

### Turn Signal Failure

If one of the turn signals fails, the turn signal indicator system flashes and sounds at a faster than normal rate.

To signal minor directional changes, such as changing lanes on a highway, move combination switch to the point of resistance only and hold it there.

To operate the turn signals continuously, move the combination switch past the point of resistance (up or down). The switch is automatically canceled when the steering wheel is turned to a large enough degree.

### **Windshield Washer Fluid Mixing Ratio**

For temperatures above freezing:

MB Windshield Washer Concentrate "S" and water

1 part "S" to 100 parts water  
(40 ml "S" to 1 gallon water).

For temperature below freezing:

MB Windshield Washer Concentrate "S" and commercially available premixed windshield washer solvent/antifreeze

1 part "S" to 100 parts solvent  
(40 ml "S" to 1 gallon solvent).

### **Windshield Wiper Smears**

If the windshield wiper smears the windshield, even during rain, activate the washer system as often as necessary. The fluid in the washer reservoir should be mixed in the correct ratio.

### **Blocked Windshield Wiper**

If the windshield wiper becomes blocked (for example, due to snow), switch off the wiper motor.

For safety reasons before removing ice or snow, remove key from steering lock. Remove blockage.

Activate combination switch again (key in steering lock position 1).

### **Emergency Operation of Windshield Wiper**

In case of windshield wiper malfunction, turn combination switch to wiper setting II.

Have the system checked at your authorized MERCEDES-BENZ dealer as soon as possible.

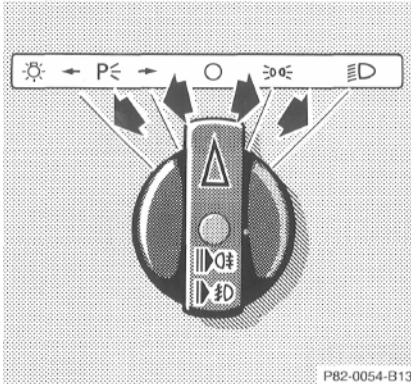

### Exterior Lamp Switch



Off



Parking lamps (also side marker lamps, taillamps, license plate lamps, instrument panel lamps)  
Canada only: When the engine is running, the low beam is additionally switched on



Parking lamps plus low beam or high beam headlamps (combination switch pushed forward)



Standing lamps, right (turn left one stop)



Standing lamps, left (turn left two stops)



Front fog lamps (pull out one stop) with parking lamps and/or low beam headlamps on.



Rear fog lamp (pull out to 2nd detent) in addition to fog lamps. Yellow indicator lamp in lamp switch comes on.

### Standing Lamps

When the vehicle is parked on the street the standing lamps (right or left side parking lamps) can be turned on, making the vehicle more visible to passing vehicles.

The standing lamps cannot be operated with the electronic key in steering lock position 2.

Note:

With the key removed and the driver's door open, a warning sounds if the vehicle's exterior lamps (except standing lamps) are not switched off.

Fog lamps will operate with the parking lamps and/or the low beam headlamps on. Fog lamps should only be used in conjunction with low beam headlamps. Consult your State or Province Motor Vehicle Regulations regarding allowable lamp operation. Fog lamps are automatically switched off when the exterior lamp switch is turned to position .

### Daytime Running Lamps (Canada only)

When the engine is running and the selector lever is in a driving position, the low beam (includes parking lamps, side marker lamps, taillamps and license plate lamps) are automatically switched on.

When shifting from a driving position to position "N" or "P", the low beam switches off (2 seconds delay).

For nighttime driving the exterior lamp switch should be turned to position  to permit activation of the high beam headlamps.

## Night Security Illumination

When exiting the vehicle after driving with the exterior lamps on, the headlamps switch on for added security for approximately 30 seconds after closing the last door. The lamp-on time period can be changed at your Mercedes-Benz dealer.

## Inside Rear View Mirror

Manually adjust the mirror.

Use your inside mirror to determine the size and distance of objects seen in the passenger convex mirror.

## Antiglare Night Position

With the key in steering lock position 2, the mirror reflection brightness responds to changes in light sensitivity. With gear selector lever in position "R", or with the interior lamp switched on, the mirror brightness does not respond to changes in light sensitivity.

Note:

The automatic antiglare function is restricted, if incoming light is not aimed directly at sensors in the mirror.

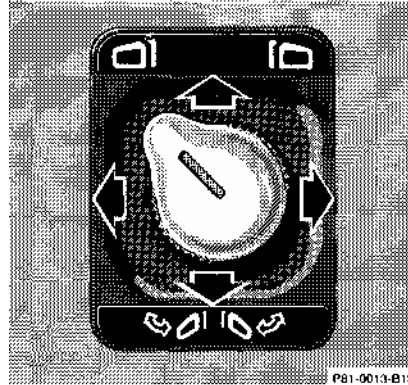

Exterior rear view mirror, left  
Exterior rear view mirror, right

## Exterior Rear View Mirrors

Turn key in steering lock to position 2 (with either front door open, the mirrors can be operated with key removed or in steering lock position 0 or 1).

Turn switch to select the mirror to be adjusted.

To adjust, move the switch forward, backward or to either side.

With the key in steering lock position 2, the driver's side mirror

reflection brightness responds to changes in light sensitivity.

With gear selector lever in position "R", or with the interior lamp switched on, the mirror brightness does not respond to changes in light sensitivity.

Note:

The exterior mirrors have electrically heated glass. The heater switches on automatically, depending on outside temperature.

If an exterior mirror housing is forcibly pivoted from its normal position, it must be repositioned by applying firm pressure until it snaps into place.

## Warning!

**Exercise care when using the passenger-side mirror. The passenger-side exterior mirror is convex (outwardly curved surface for a wider field of view). Objects in mirror are closer than they appear. Check your inside rear view mirror or glance over your shoulder before changing lanes.**

## Exterior Rear View Mirror Multiple Images

This vehicle is equipped with anti-fogging dual-pane side windows to provide extra insulation against heat, cold and noise. Because of the second pane of glass, under certain light and weather conditions a multiple image may become noticeable, especially when looking through the side windows at an outside rear view mirror.

## Storing Mirror Positions in Memory

The exterior and inside rear view mirror positions are stored in memory with the seat/head restraint/ steering column position and can be recalled when necessary, see Index.

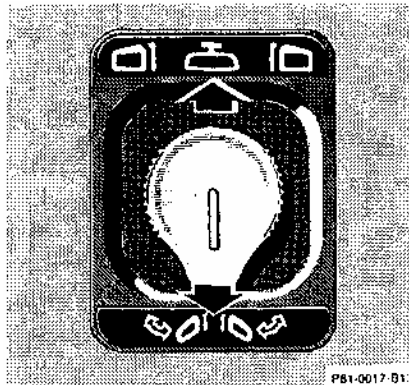

## Folding the mirrors in

Turn switch to point rearward. Press switch rearward until the mirrors are folded in.

### **Important!**

Before running the vehicle through an automatic car wash, fold mirror in, otherwise they may get damaged.

## Folding the mirrors out

Turn switch to point rearward. Press switch forward until the mirrors are folded out.

### **Important!**

Do not fold mirrors out, forcing them by hand. This will damage the operating mechanism of the mirrors.

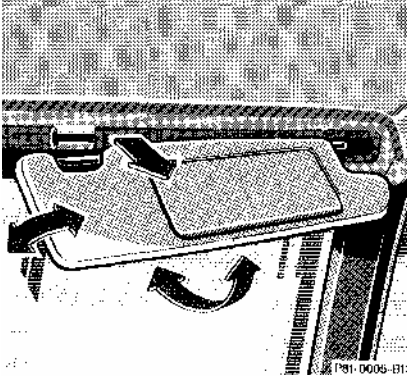

### Sun Visors

Swing sun visors down to protect against sun glare.

If sunlight enters through a side window, disengage visor from inner mounting and pivot to the side.

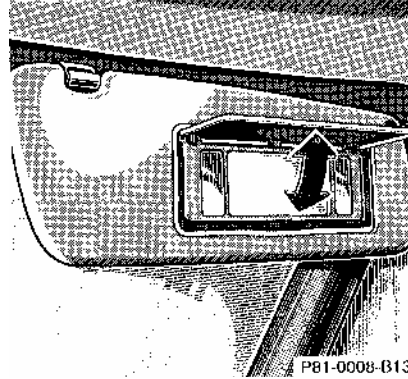

### Illuminated Vanity Mirrors

Front seats:

With the visor engaged in its inner mounting, the lamp can be switched on by opening the cover.

#### **Warning!**

**Do not use the vanity mirror while driving.**

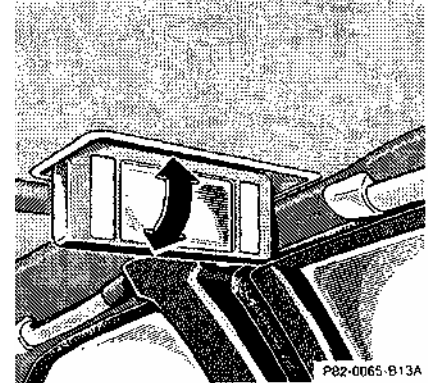

Rear seats:

Touch the cover to lower the mirror. The lamp will switch on automatically.

Close the cover and the lamp will go out.



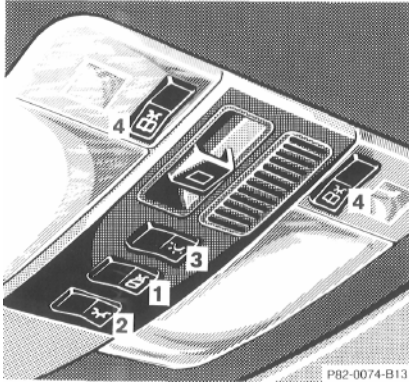

## Interior Lighting

### 1 Interior Lamps (Door contact)



**A** Interior lamps are switched on, and off delayed, when unlocking or locking the vehicle, or when opening or closing either front door. However, there will be no delay when the key is in steering lock position 2.

**B** Interior lamps switched off.

### 2 Interior Lamps



**A** Interior lamps switched off.

**B** Interior lamps switched on,

### 3 Rear Courtesy Lamps



**A** Courtesy lamps switched off.

**B** Courtesy lamps switched on.

Note:

The courtesy lamps cannot be switched off as long as a rear door is open.

### 2 Reading Lamps, Front



**A** Reading lamp switched off.

**B** Reading lamp switched on.

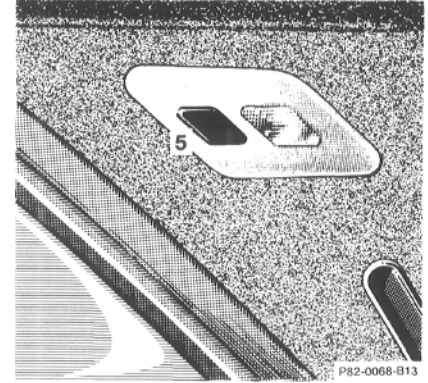

### 5 Reading Lamps, Rear

The lamps are switched on and off individually with a switch in the respective lamp.

### Entrance Lamps, Exit Lamps

The lamps are switched on and off by the door contact switches.

Note:

To prevent the vehicle battery from being discharged, do not leave doors open for a long period of time.

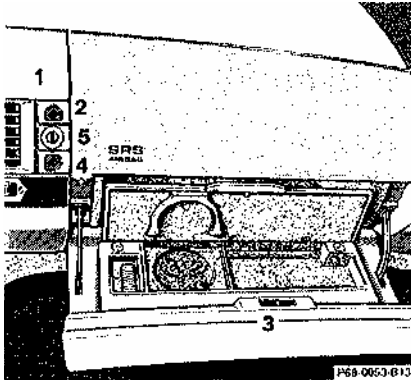

## Storage Compartments

### Caution!

Keep compartment lids closed. This will prevent stored objects from being thrown about and injuring vehicle occupants during an accident.

## Storage Compartments in the Dashboard

- 1 Storage/eyeglasses compartment
- 2 Button for storage/eyeglasses compartment
- 3 Glove box
- 4 Button for glove box
- 5 Lock

## Storage/Eyeglasses Compartment

To open: Press button (2).

### Glove Box

The glove box lid is equipped with a container for coins and small accessories.

To open: Press button (4).

Note:

The storage compartments may be locked and unlocked by using the master key in lock (5).

Locking:

Turn master key in lock (5) to the right and remove.

Unlocking:

Turn master key back to vertical position.



### **Storage Compartment below the Front Armrest**

(Vehicles without rear passenger compartment climate control)

Slide cover to

- 6 Open,
- 7 close.

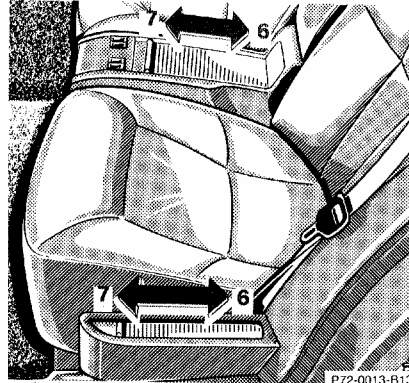

### **Storage Compartments in the Rear Passenger Compartment**

(Vehicles with individual seats)

Slide cover to

- 6 open,
- 7 close.

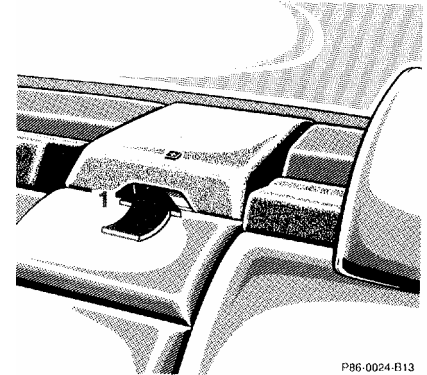

### **First Aid Kit**

#### **1 Opening lid**

The first aid kit is stored in the shelf below the rear window.

### **Stowing Things in the Vehicle**

#### **Warning!**

**To help avoid personal injury during a collision or sudden maneuver, exercise care when stowing things. Put luggage or cargo in the trunk if possible. Do not pile luggage or cargo higher than the seat backs. Do not place anything on the shelf below the rear window.**

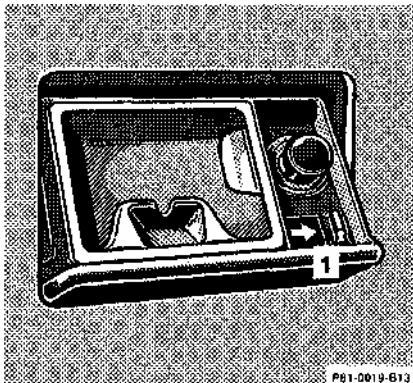

in center console, front

### Ashtrays

By touching the top of the cover lightly, the ashtray opens automatically. Prior to removing the ashtray insert move gear selector lever to position "N"

### Warning!

**With the gear selector lever in position "N", turn off the engine and set the parking brake. Otherwise the vehicle might move unintentionally.**

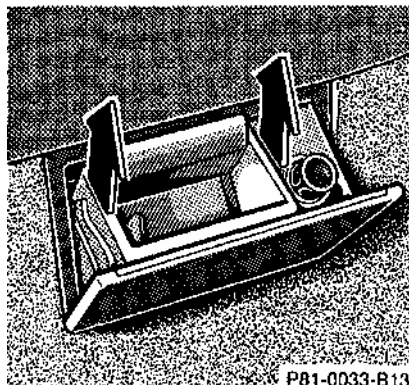

in rear doors

To remove ashtray from center console:

Push sliding knob (1) toward the right to eject the insert.

To remove ashtray from rear door: Hold left and right side of insert and pull up.

To install ashtray: Install insert into ashtray frame and push down to engage.

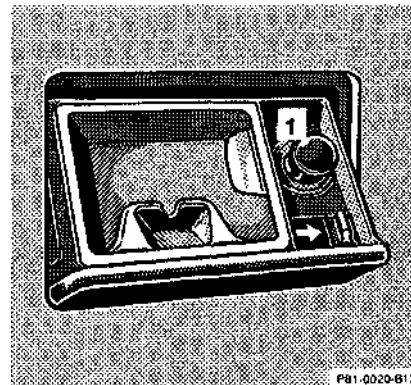

### Lighter

Turn key in steering lock to position 1 or 2.

Push in lighter (1); it will pop out automatically when hot.

### Warning!

**Never touch the heating element or sides of the lighter, hold at knob only.**

Note:

The lighter socket can be used to accommodate electrical accessories up to maximum 85 W.

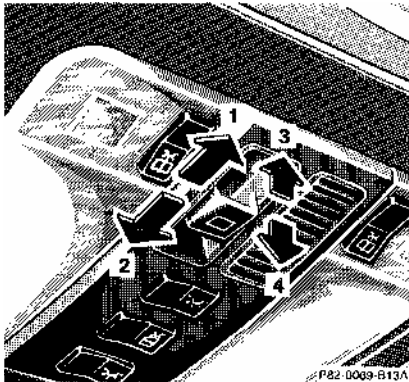

### Sliding Roof with Rear Pop-Up Feature

- 1 to slide roof open
- 2 to slide roof closed
- 3 to raise roof at rear
- 4 to lower roof at rear

Turn key in steering lock to position 1 or 2.

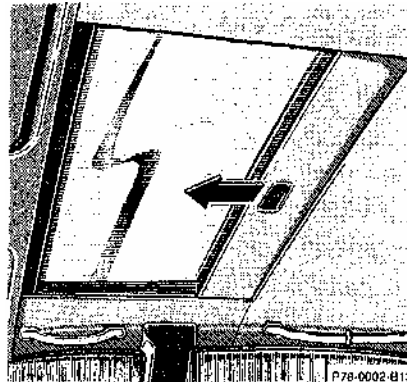

The switch is illuminated when the exterior lamps are switched on (except standing lamps).

An additional screen can be slid into the roof opening to guard against sun rays. When sliding the roof open, the screen will also retract.

### Warning!

When closing the sliding roof, be sure that there is no danger of anyone being harmed by the closing procedure.

### Notes:

The sliding roof can be opened or closed manually should an electrical malfunction occur, refer to *Emergency Operation* in Index.

The sliding roof can also be closed with the key or infrared remote control while locking the vehicle doors or trunk (see *Central Locking System* in Index).

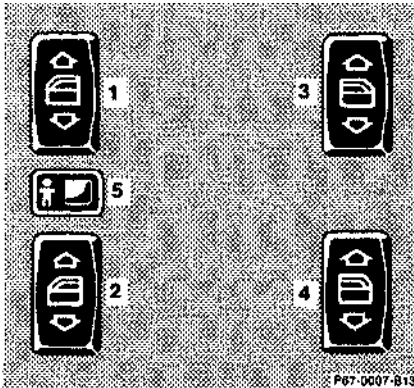

in center console, front

## Power Windows

Switches for:

- 1 left, front
- 2 left, rear
- 3 right, front
- 4 right, rear
- 5 safety switch
- 6 individual switches (rear doors)

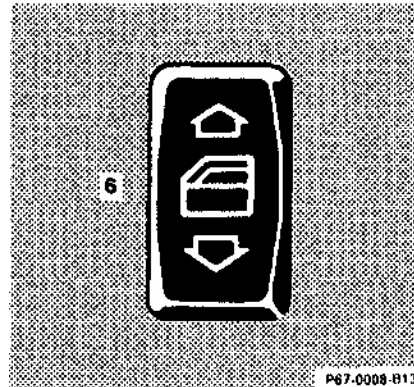

in rear doors



Turn key in steering lock to position 1 or 2.

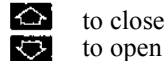

Press switch in to resistance point:



Release switch when window is in desired position.

## Express Opening and Closing

Press switch  or  past resistance point and release - window opens or closes completely.

To interrupt procedure, briefly press  or 

If the upward movement of the window is blocked during the closing procedure, the window will stop during the last few inches before closure and open slightly.

When pressing and holding the switch  to close the window, and upward movement of the window is blocked during the last few inches before closure, it will stop but not open slightly.

## Blocking of Rear Door Window Operation

If no operation of the rear windows by switch (6) (for instance by children) is desired, slide safety switch (5) to right, symbol  becomes visible.

### **Warning!**

**When closing the windows, be sure that there is no danger of anyone being harmed by the closing procedure.**

**In case of obstruction, the automatic reversal will not operate if a window is being closed by pressing the switch to its resistance point and holding it there, or when using a key or the remote control.**

**The closing procedure can be immediately reversed by either pressing the switch , turning the key to the unlocking position, or releasing and pressing the transmit button, and holding it.**

The power windows can also be closed with the key or infrared remote control while locking the vehicle doors or trunk (see *Central Locking System* in Index).

### **Warning!**

**When leaving the vehicle, always remove the key from the steering lock. Do not leave children unattended in the vehicle. Unsupervised use of vehicle equipment can cause serious personal injury.**

### **Synchronizing Power Windows**

If the power supply was interrupted (battery disconnected or empty), the windows cannot be opened or closed by the Express feature.

To resynchronize the Express feature, press  side of power window switch until the window is completely closed and hold for additional 2 seconds. Repeat procedure for each window.

The automatic full opening and closing procedure of the windows should now be restored.

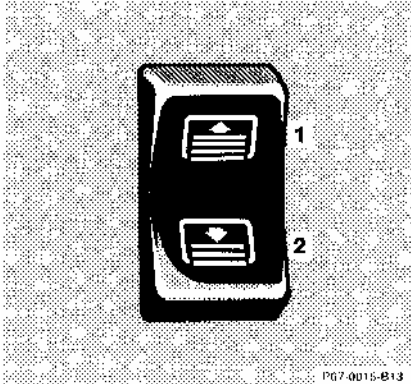

P67-0015-B13

### Rear Window Sunshade

1. Raising
2. Lowering

The switches are located on the center console and between the single rear seats

The sunshade should always be either fully raised or fully lowered

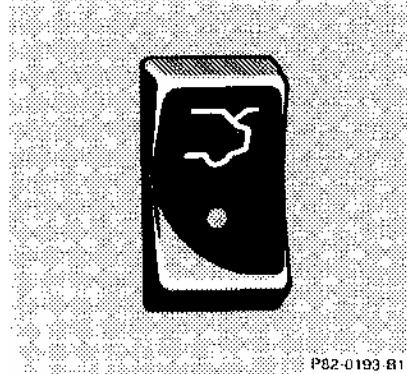

P82-0193-B13

### Trunk Lid Release Switch

The switch is located on the center console.

A minimum height clearance of 5.9 ft (1.8 m) is required to open the trunk lid.

To open the trunk, the vehicle must be parked and unlocked. Press symbol side of switch until trunk lid is open.

With vehicle centrally locked, the trunk can also be opened by using the infrared remote control. Press button

Note:

The trunk lid cannot be released by the switch when previously locked with the key. To open, refer to *Trunk, separately locked* (in Index).

### Shelf below Rear Window

#### Warning!

**The shelf below the rear window should not be used to carry objects. This will prevent such objects from being thrown about and injuring vehicle occupants during an accident or sudden maneuver.**



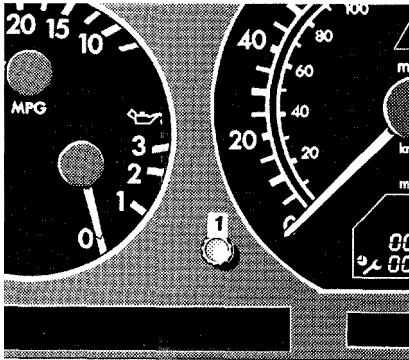

## 1 Adjusting knob

### Instrument Lamps

Rotate adjusting knob (1) to vary intensity of instrument lamps.

### Display Illumination

Press adjusting knob to briefly illuminate the display (with key removed or in steering lock position 0 or 1).

With exterior lamps switched on the display illumination becomes automatically dim.

Rotate adjusting knob clockwise to its stop to override the dimmed illumination.

### Trip odometer

To reset:

- Press adjusting knob (1) once (with key in steering lock position 2).
- Press adjusting knob (1) twice (with key removed or in steering lock position 0 or 1).

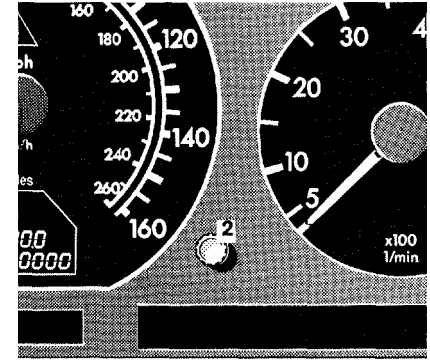

## Clock

Adjusting clock one minute ahead or back:

Pull out adjustment knob (2), briefly turn to the right respectively left and release knob.

Adjusting clock more than one minute ahead or back: Pull out adjustment knob (2), turn to the right respectively left and hold until the desired time is set. Within the first 2 seconds, the minute hand advances 8 minutes and advances another 8 minutes every additional second thereafter

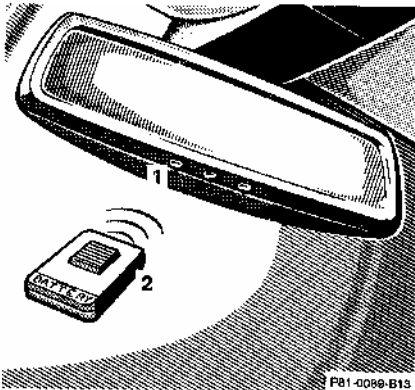

## Garage Door Opener

- 1 Remote control transmitter located on inside rear view mirror
- 2 Portable remote control transmitter

The built-in remote control is capable of operating up to three separately controlled objects.

### Warning!

**When programming a garage door opener, the door moves up or down.**

**When programming or operating the remote control make sure there is no possibility of anyone being harmed by the moving door.**

### Note:

Certain types of garage door openers are incompatible with the integrated opener. If you should experience difficulties with programming the transmitter, contact your authorized Mercedes-Benz dealer or call Mercedes-Benz Customer Assistance Center (in the U.S.A. only) at 1-800-FOR-MERCEDES.

Programming or reprogramming the remote control:

1. Turn key in steering lock to position 1 or 2.
2. Press and hold one button of the remote control located on the inside rear view mirror until its control light begins to flash at a rate of about once a second. Continue holding down the button.

### Note:

The light blinks immediately if the remote control is being programmed for the first time, or if its memory was previously erased. If you are reprogramming a previously used button, the light will flash after about 20 seconds.

3. Hold end opposite to battery of portable remote control against the inside rear view mirror transmitter to be programmed. While still holding down the button on the transmitter on the inside rear view mirror, press down the button on your portable remote control, until the inside rear view

mirror remote control light starts to flash rapidly. This means that the integrated remote control has accepted the frequency and code of the portable transmitter.

3. If you wish, repeat the procedure for each remaining button.

Operation of remote control:

1. Turn key in steering lock to position 1 or 2.
2. Select and press the appropriate button (1, 2 or 3) to activate the remote controlled device. The remote control transmitter continues to send the signal as long as the button is pressed - up to 20 seconds.

Erasing the remote control memory:

1. Turn key in steering lock to position 1 or 2.
2. Simultaneously holding down buttons 1 and 3 for approximately 20 seconds, or until the control light blinks rapidly, will erase the codes of all three channels.

## Antenna

The antenna extends when switching on the telephone.

Note:

To retract the antenna (e.g. when entering a car wash) the telephone must be switched off.

## Cellular Telephone

The vehicle is prepared for the installation of a cellular telephone. For further information and installation contact your authorized Mercedes-Benz dealer.

### Warning!

**Some jurisdictions prohibit the driver from using a cellular telephone while driving a vehicle. Whether or not prohibited by law, for safety reasons, the driver should not use the cellular telephone while the vehicle is in motion. Stop the vehicle in a safe location before answering or placing a call.**



**Driving**

## Drinking and Driving

### Warning!

Drinking and driving can be a very dangerous combination. Even a small amount of alcohol or drugs can affect your reflexes, perceptions and judgement.

The possibility of a serious or even fatal accident is sharply increased when you drink and drive.

Please don't drink and drive or allow anyone to drive after drinking.

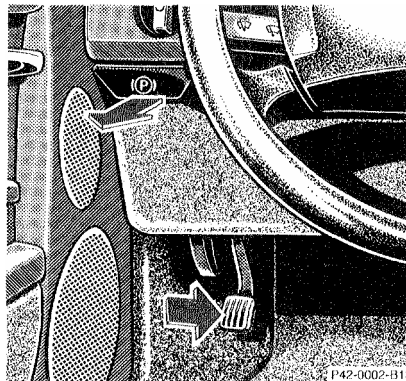

## Parking Brake

To engage, depress parking brake pedal. When the key is in steering lock position 2, the brake warning lamp in the instrument cluster should come on brightly.

To release the parking brake, pull handle on instrument panel. The brake warning lamp in the instrument cluster should go out.

A warning sounds, if you start to drive without having released the parking brake.

Also see *Brake Warning Lamp Test* in Index.

## Driving Off

Apply the service brakes to test them briefly after driving off. Perform this procedure only when the road is clear of other traffic.

Warm up the engine smoothly. Do not place full load on the engine until the operating temperature has been reached.

When starting off on a slippery surface, do not allow one drive wheel to spin for an extended period.

### Warning!

**Keep driver's foot area clear at all times. Objects stored in this area may impair pedal movement.**

## Automatic Transmission

The automatic transmission selects individual gears automatically, dependent upon

- Selector lever position
- Accelerator position
- Vehicle speed

### Important!

When parking the car or before working on the vehicle with the engine running, firmly depress the parking brake pedal and shift the selector lever into "P".

### Driving

The selector lever is automatically locked while in position "P". To move the selector lever out of position "P", the service brake pedal must be firmly depressed before the shift lock will release.

Shift selector lever to the desired driving position only when the engine is idling and the service brake is applied. Do not release the brake until ready to drive.

The vehicle may otherwise start creeping when the selector lever is in drive or reverse position.

### Warning!

**It is dangerous to shift the selector lever out of "P" or "N" if the engine speed is higher than idle speed. If your foot is not on the brake pedal, the car could accelerate quickly forward or in reverse. You could lose control of the car and hit someone or something. Only shift into gear when the engine is idling normally and when your right foot is firmly on the brake pedal.**

### Important!

After selecting any driving position from "N" or "P", wait a moment to allow the gear to fully engage before accelerating, especially when the engine is cold.

## Accelerator position

Partial throttle = early upshifting  
= normal acceleration

Full throttle = later upshifting  
= rapid acceleration

Kickdown (depressing the accelerator beyond full throttle) = downshifting to next lowest gear = maximum acceleration. Once the desired speed is attained, ease up on the accelerator - the transmission shifts up again.

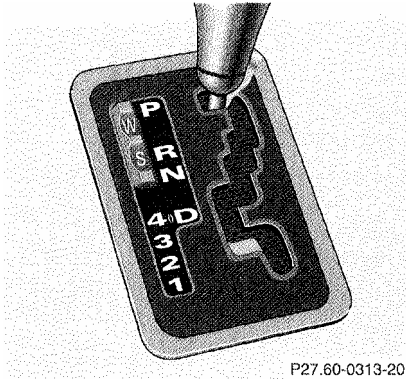

P27.60-0313-20

### Selector Lever Positions

The automatic gear shifting process can be adapted to specific operating conditions using the selector lever.

#### **P** Parking position.

The parking position is to be used when parking the vehicle. Engage only with the car stopped. The parking position is not intended to serve as a brake when the vehicle is parked. Rather, the driver should always use the parking brake in addition to placing the selector lever in park to secure the vehicle.

Note:

The key can be removed from the steering lock only with the selector lever in position "P". With the key removed, the selector lever is locked in position "P".

#### **R** Reverse gear.

Shift to reverse gear only with the car stopped.

#### **N** Neutral.

No power is transmitted from the engine to the rear axle. When the brakes conditions are released, the vehicle can be moved freely (pushed or towed). Do not engage "N" while driving except to coast when the vehicle is in danger of skidding (e.g. on icy roads, see *Winter Driving Instructions* in Index).

#### **Important!**

Coasting the vehicle, or driving for any other reason with selector lever in "N", can result in transmission damage that is not covered by the Mercedes-Benz Limited Warranty.

**D** The transmission automatically upshifts to 5th gear. Position "D" provides optimum driving characteristics under all normal operating.

**4** Upshift to 4th gear only. Suitable for performance driving.

**3** Upshift to 3rd gear only. Suitable for moderately steep hills. Since the transmission does not shift higher than 3rd gear, this gear selection will allow use of the engine's braking power downhill.

**2** Upshift to 2nd gear only. For driving in mountainous regions or under extreme operating conditions. This gear selection will allow use of the engine's braking power when descending steep grades.

**1** In this position, the engine's braking effect is utilized by shifting into 1st gear. Use this position while descending very steep or lengthy downgrades and only at speeds below 40 mph (60 km/h).



## Important

With selector lever in position "D", "4" or "3", upshifting from 1st to 2nd to 3rd gear is delayed depending on vehicle speed and engine temperature. This allows the catalytic converter to heat up more quickly to operating temperatures.

During the brief warm-up period this delayed upshift and increased engine noise might be perceived as a malfunction. However, neither the engine nor transmissions are negatively affected by this mode of operation.

The delayed upshift is effective with vehicle speeds below 31 mph (50 km/h) at partial throttle and engine temperatures below 95°F (35°C).

To avoid overrevving the engine when the selector lever is moved to a lower driving range, the transmission will not shift to a lower gear as long as the vehicle speed exceeds the speed limit of that gear.

To prevent the engine from laboring at low RPMs, do not allow the engine speed to drop too low on uphill gradients.

Depending on the degree of the incline, shift selector lever to a lower gear range early enough to maintain engine RPM within the best torque range.

## Warning!

**On slippery road surfaces, never downshift in order to obtain braking action. This could result in rear wheel slip and reduced vehicle control. Your vehicle's ABS will not prevent this type of loss of control.**

## Maneuvering

To maneuver in tight areas, e.g. when pulling into parking space, control the car speed by gradually releasing the brakes. Accelerate gently and never abruptly step on the accelerator.

To rock a car out of soft ground (mud or snow), alternately shift from forward to reverse, while applying slight partial throttle.

Rocking a car free in this manner may cause the ABS warning lamp to come on. Turn off and restart the engine to clear the malfunction indication.

## Stopping

For brief stops, e.g. at traffic lights, leave the transmission in gear and hold vehicle with the service brake.

For longer stops with the engine idling, shift into "N" or "P".

When stopping the car on an uphill incline, do not hold it with the accelerator, use the brake. This avoids unnecessary transmission heat build up.

## Warning!

**Getting out of your car with the selector lever not fully engaged in position "P" is dangerous. When parked on a steep incline, position "P" alone may not prevent your vehicle from moving, possibly hitting people or objects.**

**Always set the parking brake in addition to shifting to position "P".**

**When parked on an incline, also turn front wheel against curb.**

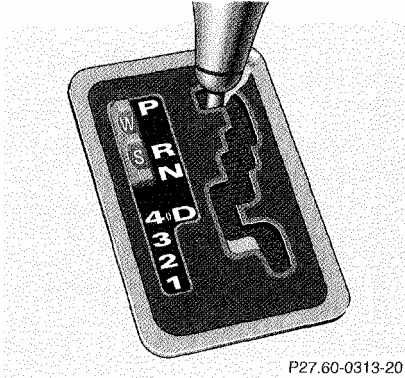

P27.60-0313-20

### Program Mode Selector Switch

The transmission is provided with a selector switch for Standard "S" and Winter/Wet (snow and ice) "W" program modes.

### Important!

**Always be certain of the program mode selected since the vehicle driving characteristics change with the selection of the program mode.**

**S** Standard mode  
Press switch on symbol "S". Use this mode for all regular driving. The vehicle starts out in 1st gear.

**W** Winter/Wet (snow and ice) mode

Press switch on symbol "W". The vehicle starts out in 2nd gear, except with selector lever in 1st gear, or with accelerator pedal in kick-down position.

The "W" mode helps to improve traction and driving stability of the vehicle.

With hard acceleration the upshifts occur at lower vehicle and engine speeds than in the "S" program mode.

### Caution!

Never change the program mode when the selector lever is out of position "P". It could result in a change of driving characteristics for which you may not be prepared.

### Emergency Operation (Limp Home Mode)

If vehicle acceleration worsens, or the transmission no longer shifts, the transmission is most likely operating in Limp Home Mode which engages when there is a malfunction at the transmission. This condition may be accompanied by the "CHECK ENGINE" malfunction indicator lamp in the instrument cluster coming on.

In this mode only the 2nd gear or reverse gear can be activated.

To engage 2nd gear or reverse:

1. Stop the vehicle.
2. Move selector lever to position "P".
3. Turn off the engine.
4. Wait 10 seconds.
5. Restart the engine,
6. Move selector lever to position "D" (for 2nd gear), or move selector lever to position "R" (for reverse gear).

Have the transmission checked at your authorized Mercedes-Benz dealer as soon as possible.

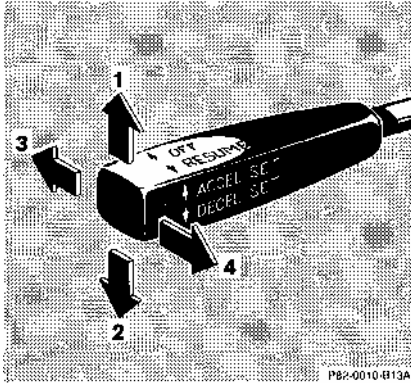

## Cruise Control

Any given speed above approximately 22 mph (35 km/h) can be maintained with the cruise control by operating the lever.

- 1 Accelerate and set:  
Lift lever briefly to set speed. Hold lever up to accelerate.
- 2 Decelerate and set:  
Depress lever briefly to set speed. Hold lever down to decelerate.

Normally the vehicle is accelerated to the desired speed with the accelerator.

Speed is set by briefly pushing the lever to position 1 or 2. The accelerator can be released.

The speed can be increased (e.g. for passing) by using the accelerator. As soon as the accelerator is released, the previously set speed will be resumed automatically.

If a set speed is to be increased or decreased slightly, e.g. to adapt to the traffic flow, hold lever in the appropriate direction for increases or decreases in 0.6 mph (1 km/h) increments. When the lever is released, the newly set speed remains.

## 3 Canceling

To cancel the cruise control, briefly push lever to position 3. When you step on the brake or the vehicle speed drops below approx. 22 mph (35 km/h), for example when driving upgrade, the cruise control will be canceled.

If the cruise control cancels by itself and remains inoperative until the engine is restarted, have the system checked at your authorized Mercedes-Benz dealer as soon as possible.

## 4 Resume

If the lever is briefly pushed to position 4 when driving at a speed exceeding approx. 22 mph (35 km/h), the vehicle resumes the speed which was set prior to the cancellation of the cruise control. The last memorized speed is canceled when the key in the steering lock is turned to position 1 or 0.

Note:

If the engine does not brake the vehicle sufficiently while driving on a downgrade, the speed you set on the cruise control may be exceeded and you may have to step on the brake pedal to slow down. As soon as the grade eases, the cruise controlled speed will again be maintained as long as the brakes were not previously applied, or the lever may be used to resume the previously set speed if the brakes were applied.

**Caution!**

Moving gear selector lever to position "N" switches the cruise control off.

**Warning!**

**Only use the cruise control if the traffic and weather conditions make it advisable to travel at a steady speed.**

- **The use of cruise control can be dangerous on winding roads or in heavy traffic because conditions do not allow safe driving at a steady speed.**
- **The use of cruise control can be dangerous on slippery roads. Rapid changes in tire adhesion can result in wheel spin and loss of control.**

**The "Resume" function should only be operated if the driver is fully aware of the previously set speed and wishes to resume this particular preset speed.**

## **Parking Assist (Parktronic) (optional)**

The Parktronic assists the driver during parking maneuvers. It visually and audibly indicates the distance between the vehicle and an obstacle.

The front area of the vehicle is monitored when driving forward.

When reversing, the front as well as the rear areas are monitored.

With the key in steering lock position 2, the Parktronic engages automatically at speeds up to approx. 10 mph (15 km/h) and deactivates during higher speeds.

The Parktronic can be switched off by a control switch located in the center console.

## **Warning!**

**The responsibility during parking and other critical maneuvers rests always with the driver.**

**The operational function of the Parktronic can be affected by dirty sensors, especially at times of snow and ice.**

**Interference caused by other ultrasonic signals (e.g. working jackhammers or the air brakes of trucks) should be taken into consideration.**

## **Sensors**

A total of 10 sensors monitor the vehicle front and rear areas. Six sensors are located in the front bumper, four sensor in the rear bumper.

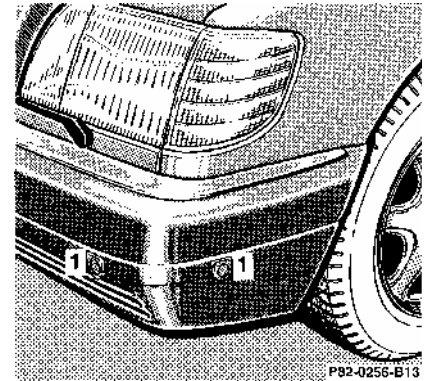

**1** Sensor located in bumper

For proper operation of the Parktronic always keep the sensors clean.

Use a mild car wash detergent, such as Mercedes-Benz approved Car Shampoo, with plenty of water.

When using a steam cleaner or power washer, aim nozzle only briefly from a minimum distance of 4 in. (10 cm) at sensors.

To prevent scratches, never apply strong force or use a hard cloth when cleaning the sensors. Do not attempt to wipe dirty sensors with a dry cloth or sponge.

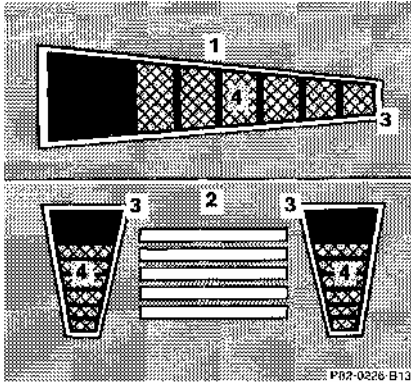

## Warning Indicators

- 1 Warning indicators for front area
- 2 Warning indicators for rear area
- 3 Frame
- 4 Segments

Visual and audible signals indicate to the driver the distance between the vehicle and an obstacle.

Warning indicators for the front area are located above the left and center air outlets in the dashboard.

Warning indicator for the rear area are located in the rear interior lamp.

The frames are illuminated in white when the Parktronic is engaged.

Each of the warning indicators has 6 yellow and 2 red segments.

As soon as the sensors realize an obstacle, one or more segments light up, depending on the distance.

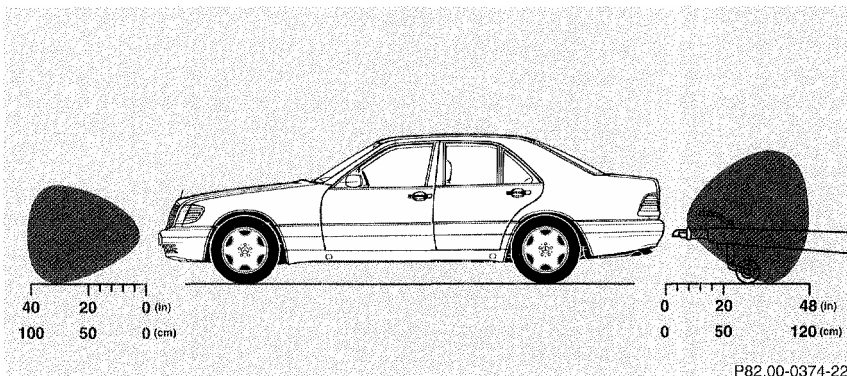

### Monitoring reach of sensors

#### Front bumper.

center approx. 40 in (100 cm)  
 corner approx. 24 in (60 cm)

#### Rear bumper:

center approx. 48 in (120 cm)  
 corner approx. 32 in (80 cm)

The first yellow segment lights up at above distance. Additional segments light up as the vehicle comes closer to the obstacle.

### Minimum distance between vehicle and obstacle

#### Front

corners approx. 6 in (15 cm)  
 center approx. 8 in (20 cm)  
 rear approx. 8 in (20 cm)

One or both red segments light up. In addition, an alarm sounds for approximately 3 seconds.

The obstacle may not be recognized if outside the shaded sensor field, and no longer be indicated when approaching it any closer (warning indicators go out).

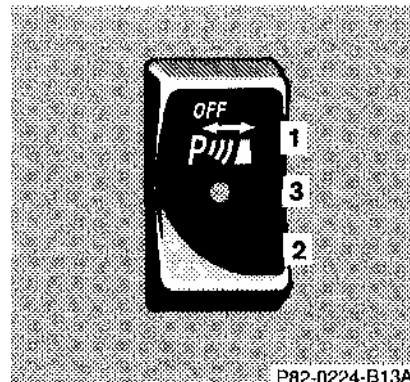

### Parktronic Switch

- 1 Parktronic switched off
- 2 Parktronic switched on
- 3 Indicator light - comes on when Parktronic is switched off.

The switch is located on the center console,

### **Parktronic Malfunction**

All red segments of the warning indicators light up, and a warning sounds for 3 seconds, if Parktronic does not function properly.

A dirty sensor could be the reason.

After cleaning the sensors, turn key in steering lock to position 2. If the defect continues to be displayed, have the system checked at your authorized Mercedes-Benz dealer.

### **Charge Indicator Lamp**

Should the charge indicator lamp fail to come on prior to starting when the key is in steering lock position 2 or should it fail to go out after starting or during operation, this indicates a fault which must be repaired at an authorized Mercedes-Benz dealer immediately.

If the charge indicator lamp comes on while the engine is running, this may indicate that the poly-V-belt has broken. Should this condition occur, the poly-V-belt must be replaced before continuing to operate the vehicle. Otherwise, the engine will overheat due to an inoperative water pump which may result in damage to the engine.

Do not continue to drive the vehicle with the charge indicator lamp illuminated. Doing so could result in engine damage that is not covered by the Mercedes-Benz Limited Warranty.

### **Engine Oil Pressure Gauge**

The oil pressure at idle speed may drop if the engine is at operating temperature. This will not jeopardize the engine's operational reliability.

Pressure must, however, rise immediately upon acceleration.

Note:

If the oil pressure gauge needle drops to "0" with the engine running, then damage to the engine may occur with continued operation. Turn off engine immediately and contact an authorized Mercedes-Benz dealer. Do not operate the car until the condition is repaired.



### **Low Engine Oil Level Warning Lamp**

With the key in steering lock position 2, the oil level warning lamp comes on and should go out when the engine is running.

If the warning lamp comes on with the engine running and at operating temperature, the engine oil level has dropped to approximately the minimum mark on the dipstick.

When this occurs, the warning lamp will first come on intermittently and then stay on if the oil level drops further.

If no oil leaks are noted and there is no loss in engine oil pressure, continue to drive to the nearest service station where the engine oil should be topped to the "full" mark on the dipstick with an approved oil.

The low engine oil level warning light should not be ignored. Extended driving with the light illuminated could result in engine damage that is not covered by the Mercedes-Benz Limited Warranty.

In addition to the warning lamp, the engine oil level should be periodically checked with the dipstick, for example during a fuel stop, or before a long trip (see Index).

### **Engine Oil Consumption**

Engine oil consumption checks should only be made after the break-in period. During the break-in period, higher oil consumption may be noticed and is normal. Frequent driving at high engine speeds results in increased consumption.

### **Fuel Consumption Gauge**

While driving, current fuel consumption is indicated in miles per gallon (mpg), or in Canada liters per 100 kilometers (l/100 km).

With the engine switched off, the needle reads "0".

Due to system design, minimum consumption is indicated at engine idle speed.

### **Fuel Reserve Warning Lamps**

With the key in steering lock position 2, the fuel reserve warning lamps come on and should go out when the engine is running.

If the warning lamps do not go out after starting the engine or if they come on while driving, it indicates that the fuel level is down to the reserve quantity of approx. 3.3 gal (12.5 liters).

The warning lamp blinks when the fuel cap is not closed, or the fuel system has a leak. Retighten cap and see if lamp goes out.

If the warning lamp continues to blink after closing the fuel cap correctly, have the fuel system checked at your authorized Mercedes-Benz dealer as soon as possible.

## Outside Temperature Indicator

The temperature sensor is located in the front bumper area. Due to its location, the sensor can be affected by road or engine heat during idling or slow driving. This means that the accuracy of the displayed temperature can only be verified by comparison to a thermometer placed next to the sensor, not by comparison to external displays (e.g. bank signs, etc.).

Adaptation to ambient temperature takes place in steps and depends on the prevailing driving conditions (stop-and-go or moderate, constant driving) and amount of temperature change.

### Warning!

**The outside temperature indicator is not designed to serve as an Ice-Warning Device and is therefore unsuitable for that purpose. Indicated temperatures just above the freezing point do not guarantee that the road surface is free of ice.**

## Tachometer

Red marking on tachometer: Excessive engine speed.

Avoid this engine speed, as it may result in engine damage that is not covered by the Mercedes-Benz Limited Warranty. For engine protection, the fuel supply is interrupted if the engine is operated within the red marking.

## Coolant Temperature Gauge

If the antifreeze mixture is effective to -30°C (-22°F), the boiling point of the coolant in the pressurized cooling system of your vehicle is approx. 130°C (266 °F).

During severe operating conditions and stop-and-go city traffic, the coolant temperature may rise close to the red marking.

The engine should not be operated with the coolant temperature in the red zone. The engine should not be operated with the coolant temperature in the red zone. Doing so may cause serious engine damage which is not covered by the Mercedes-Benz Limited Warranty.

### Warning!

- **Driving when your engine is badly overheated can cause some fluids which may have leaked into the engine compartment to catch fire. You could be seriously burned. Turn off the engine and get out of the car until it cools down.**
- **Steam from an overheated engine can cause serious burns and can occur just by opening the engine hood. Stay away from the engine if you see or hear steam coming from it. Turn off the engine and do not stand near the car until it cools down.**

**Turn off the engine, get out of the car and do not stand near the car until it cools down.**

### **Low Engine Coolant Level Warning Lamp**

With the key in steering lock position 2, the warning lamp comes on and goes out with the engine running.

If the warning lamp does not go out after starting the engine, or if it comes on while driving, then the coolant level has dropped below the required level. If no leaks are noticeable and the engine temperature does not increase, continue to drive to the nearest service station and have coolant added to the coolant system (see Index).

The low engine coolant level warning light should not be ignored. Extended driving with the light illuminated may cause serious engine damage not covered by the Mercedes-Benz Limited Warranty.

In cases of major or frequent minor coolant loss, have the cooling system checked at your authorized Mercedes-Benz dealer as soon as possible.

Note:

Do not drive without coolant in the cooling system. The engine will overheat causing major engine damage.

Monitor the coolant temperature gauge while driving.

### **Warning!**

**Do not spill antifreeze on hot engine parts. Antifreeze contains ethylene glycol which may burn if it comes into contact with hot engine parts. You can be seriously burned.**

### **Low Windshield and Headlamp Washer System Fluid Level Warning Lamp**

With the key in steering lock position 2, the warning lamp comes on and goes out with the engine running.

If the warning lamp comes on with the engine running, the level of the reservoir has dropped to approx.  $\frac{1}{4}$  of the total volume. The reservoir should be refilled with MB Windshield Washer Concentrate "S" and water (or commercially available premixed windshield washer solvent/antifreeze, depending on ambient temperature - see Index) at the next opportunity. The reservoir for the windshield and headlamp washer system is located in the engine compartment next to the radiator.

### **Exterior Lamp Failure Indicator Lamp**

With the key in steering lock position 2, a dim indicator lamp comes on, and goes out when the engine is running.

With the key in steering lock position 2 or with the engine running, a bright illumination of this lamp indicates an exterior lamp failure.

If an exterior lamp fails, the indicator lamp will come on only when that lamp is switched on.

If a brake or turn signal lamp fails, the lamp failure indicator will come on when applying the brake or actuating the turn signal and stay on until the engine is turned off.

Note:

The indicator lamp will also come on if an incorrect bulb is installed.

If additional lighting equipment is installed (e.g. auxiliary headlamps etc.) be certain to connect into the fuse before the failure indicator monitoring unit in order to avoid damaging the system.

### **Seat Belt Warning Lamp**

With the key in steering lock position 2, the warning lamp comes on and an audible warning sounds for a short time if the driver's seat belt is not fastened.

After starting the engine, the warning lamp blinks for a brief period to remind the driver and passengers to fasten seat belts before driving off.

### **Brake Pad Wear Indicator Lamp**

The brake pad wear indicator lamp in the instrument cluster comes on when the key in the steering lock is turned to position 2 and goes out when the engine is running.

If the indicator lamp lights up during braking, this indicates that the front wheel brake pads are worn down.

Have the brake system checked at your authorized Mercedes-Benz dealer as soon as possible.

## Brake Warning Lamp

The brake warning lamp will come on with the key in steering lock position 2 and should go out when the engine is running.

The brake warning lamp will come on:

- when there is insufficient brake fluid in the reservoir (engine running and parking brake released) or
- when the parking brake is set (engine running).

## Warning!

**Driving with the brake warning lamp on can result in an accident. Have your brake system checked immediately if the brake warning lamp stays on. Don't add brake fluid before checking the brake system. Overfilling the brake fluid reservoir can result in spilling brake fluid on hot engine parts and the brake fluid catching fire. You can be seriously burned.**

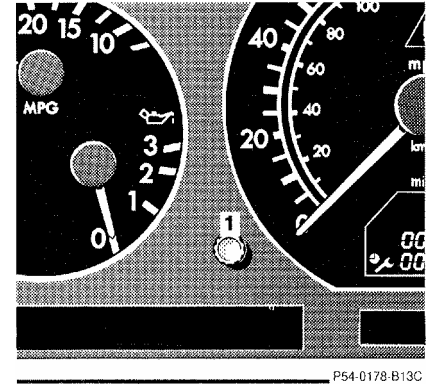

When the minimum mark on the reservoir is reached, have the brake system checked for brake pad thickness and leaks.

To test the brake warning lamp, turn key in steering lock to position 2. The brake warning lamp comes on, and should go out when the engine is running.





## Flexible Service System (FSS)

The FSS permits a flexible service schedule that is directly related to the operating conditions of the vehicle.

The symbol  or  appears in the main odometer field prior to the next suggested service.

Depending on operating conditions throughout the year, the next service is calculated and displayed in days or distance remaining.

The message is displayed for approx. 10 seconds when turning the key in steering lock to position 2, or it can be canceled manually by pressing button (1).

Once the suggested term has passed, the message plus symbol  or , preceded by a – (minus symbol) blinks, when turning the key to position 2.

The FSS display can also be called up for approx. 10 seconds with display illuminated by pressing button (1) twice.

Following a completed service the Mercedes-Benz dealer sets the counter to 10 000 miles (Canada: 15 000 km) and 365 days.

The counter can also be set by any individual. To do so:

1. Turn key in steering lock to position 2.
2. Within 4 seconds press button (1) twice.
3. The present status for days or distance is displayed. Within 10 seconds turn key in steering lock to position 0.
4. Press and hold button (1), while turning key in steering lock to position 2 again. The present status for days or distance is displayed once more. Continue to hold button (1).

After approx. 10 seconds a signal sounds, and the display shows 10 000 miles (Canada: 15 000km).

5. Release button (1).

If the FSS counter was inadvertently reset, have a Mercedes-Benz dealer correct it.

Notes:

When disconnecting vehicle battery for one or more days at a time, such days will not be counted. Any such days not counted by the FSS can be added by your Mercedes-Benz dealer.

The interval between services is determined by the kind of vehicle operation. Driving at extreme speeds, and cold starts combined with short distance driving in which the engine does not reach normal operating temperature, reduce the interval between services.

The FSS allows for distances between 10 000 miles (Canada: 15 000 km) and 15 000 miles (Canada: 22 500 km), or from 365 to 730 days between services.

However you choose to set your reference numbers, the scheduled services as posted in the Service Booklet must be followed to properly care for your vehicle.

## Antilock Brake System (ABS)

### Important!

The ABS improves steering control of the vehicle during braking maneuvers. Do not pump the brake pedal, rather use firm, steady brake pedal pressure. Pumping the brake pedal defeats the purpose for ABS and significantly reduces braking effectiveness.

The ABS prevents the wheels from locking up above a vehicle speed of approximately 5 mph (8 km/h) independent of road surface conditions.

At the instant one of the wheels is about to lock up, a slight pulsation can be felt in the brake pedal, indicating that the ABS is in the regulating mode. Keep firm and steady pressure on the brake pedal while experiencing the pulsation.

On slippery road surfaces, the ABS will respond even with light brake pedal pressure because of the increased likelihood of locking wheels. The pulsating brake pedal can be an indication of hazardous road conditions and functions as a reminder to take extra care while driving.

## ABS Control

The ABS malfunction indicator lamp in the instrument cluster comes on with the key in steering lock position 2 and should go out when the engine is running.

If the charging voltage falls below 10 volts, the malfunction indicator lamp comes on and the ABS is switched off. When the voltage is above this value again, the malfunction indicator lamp should go out and the ABS is operational.

With the ABS malfunctioning, the ESP, if vehicle so equipped, is also switched off. Both malfunction indicator lamps come on with the engine running

If the ABS malfunction indicator lamp does not go out or comes on while driving, it indicates that the ABS has detected a malfunction and has switched off. In this case, the brake system functions in the usual manner, but without antilock assistance.

Have the system checked at your authorized Mercedes-Benz dealer as soon as possible.

## Warning!

**Even the ABS cannot prevent the natural laws of physics from acting on the vehicle. The ABS cannot prevent accidents, including those resulting from excessive speed in turns, following another vehicle too closely, or aquaplaning. Only a safe, attentive, and skillful driver can prevent accidents. The capabilities of an ABS equipped car must never be exploited in a reckless or dangerous manner which could jeopardize the user's safety or the safety of others.**

Note:

To alert following vehicles to slippery road conditions you discover, operate your hazard warning flashers as appropriate.

## **Brake Assist System (BAS)**

### **Warning!**

**BAS cannot prevent the natural laws of physics from acting on the vehicle, nor can it increase braking efficiency beyond that afforded by the condition of the vehicle brakes and tires or the traction afforded. The BAS cannot prevent accidents, including those resulting from excessive speed in turns, following another vehicle too closely, or aquaplaning. Only a safe, attentive, and skillful driver can prevent accidents. The capabilities of a BAS equipped car must never be exploited in a reckless or dangerous manner which could jeopardize the user's safety or the safety of others.**

The Brake Assist System is designed to maximize the vehicle's braking capability during emergency braking maneuvers by having maximum power boost applied to the brakes more quickly in emergency braking conditions than might otherwise be afforded solely by the driver's braking style. This can help reduce braking distances over what ordinary driving and braking style might do. The BAS complements the Antilock Brake System (ABS).

To receive the benefit of the system you must apply continuous full braking power during the stopping sequence. Do not reduce brake pedal pressure.

Once the brake pedal is released, the BAS is deactivated

The indicator lamps for the ESP are combined with the BAS indicator lamp.

The BAS/ESP malfunction indicator lamp in the instrument cluster come on with the key in steering lock position 2 and should go out with the engine running.

If the BAS/ESP malfunction indicator lamp comes on while the engine is running, a malfunction has been detected in either system. As a result, it is possible that now only partial engine output will be available, and pressing the accelerator pedal will require more effort. If the BAS malfunctions, the brake system functions in the usual manner, but without BAS.

If the charging voltage falls below 10 volts, the malfunction indicator lamp comes on and the BAS is switched off. When the voltage is above this value again, the malfunction indicator lamp should go out and the BAS is operational.

With the ABS malfunctioning, the BAS or ESP is also switched off. Both malfunctions indicator lamps come on with the engine running.

Have the BAS or ESP checked at your authorized Mercedes-Benz dealer as soon as possible.



## **Electronic Stability Program (ESP)**

The ESP enhances directional control and improves traction of the vehicle under any driving condition.

Over/understeering of the vehicle is counteracted by applying brakes to the left or right side wheels. The ESP warning lamp, located in the speedometer dial, starts to flash.

### **Important!**

If the ESP warning lamp flashes, adapt your speed and driving to the prevailing road conditions.

### **Caution!**

If the vehicle is towed with the front axle raised (see *Towing the vehicle* in Index), the engine must be shut off. Otherwise, the electronic stability program will immediately be engaged and will apply the rear wheel brakes.

Notes:

The indicator lamp for the ESP is combined with that of the BAS.

With the key in steering lock position 2, the yellow BAS/ESP malfunction indicator lamps in the instrument cluster and the yellow warning lamp in the speedometer dial come on. They must go out when the engine is running.

If the BAS/ESP malfunction indicator lamp comes on with the engine running, a malfunction has been detected in either system. Pressing the accelerator pedal will require greater effort. Only partial engine output will be available.

Have the BAS or ESP checked at your authorized Mercedes-Benz dealer as soon as possible.

With the ABS malfunctioning, the ESP is also switched off.

Driving the vehicle with varied size tires will cause the wheels to rotate at different speeds, therefore the electronic stability program may activate (yellow ESP malfunction indicator lamp in instrument cluster comes on). For this reason, all wheels, including the spare wheel, must have the same tire size.

When testing the parking brake on a brake test dynamometer, the engine must be shut off. Otherwise, the electronic stability program will immediately be engaged and will apply the rear wheel brakes.

In winter operation, the maximum effectiveness of the electronic stability program is only achieved with Mercedes-Benz recommended M + S radial-ply tires and/or snow chains.



### ESP Control Switch

ESP control switch located in center console

To improve the vehicle's traction when driving with snow chains, or starting off in deep snow, sand or gravel, press the upper half of the ESP switch. The ESP warning lamp, located in the speedometer dial, is continuously illuminated.

With the ESP system switched off, the engine torque reduction feature is cancelled. Therefore, the enhanced vehicle stability offered by ESP is unavailable.

Adapt your speed and driving to the prevailing road conditions.

A portion of the ESP system remains active, even with the switch in the OFF position.

If one drive wheel loses traction and begins to spin, the brake is applied until the wheel regains sufficient traction. The traction control engages at vehicle speeds up to approximately 24 mph (40 km/h), and switches off at 50 mph (80 km/h).

Note:

Avoid spinning of one drive wheel. Doing so may cause serious damage to the drive train which is not covered by the Mercedes-Benz Limited Warranty.

The ESP warning lamp, located in the speedometer dial, starts to flash at any vehicle speed as soon as the tires lose traction and the wheels begin to spin. To switch off: press lower half of the switch (the ESP warning lamp in the speedometer dial goes out).

To return to the enhance vehicle stability offered by ESP: press lower half of the switch (the ESP warning lamp in the speedometer dial goes out).

### Important!

If the ESP warning lamp flashes:

- during take-off, apply as little throttle as possible,
- while driving, ease up on the accelerator.

## Adaptive Damping System (ADS)

Depending upon road surface conditions, load, driving style, ADS will automatically adjust the optimal ride firmness.

The malfunction indicator lamp comes on with the key in steering lock position 2 and goes out when the engine is running.

If the malfunction indicator lamp stays on after the engine is running or comes on while driving, then the system has detected a malfunction.

We recommend that you visit an authorized Mercedes-Benz dealer as soon as possible to have the system checked out.

Note:

If the power supply was interrupted (battery disconnected or empty), the malfunction indicator lamp will light up when the engine is running.

Turn the steering wheel from full left to full right lock position. The light should go out.

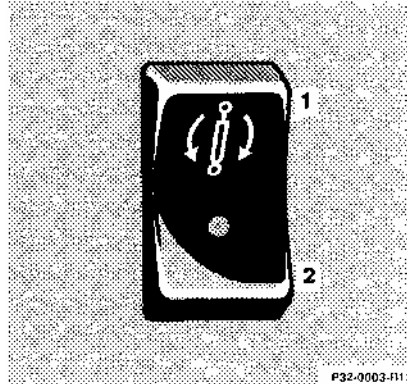

## Adaptive Damping System Adjustment

The switch is located in the center console.

- 1** Firm dampening program.  
This setting should be used for sporty driving.  
During the setting for sporty driving the indicator lamp in the switch lights up.
- 2** Soft dampening program.  
This setting should be used for regular driving.

## Emission Control

Certain systems of the engine serve to keep certain components of the exhaust gases within permissible limits required by law.

These systems, of course, will function properly only when maintained strictly according to factory specifications. Any adjustments on the engine should, therefore, be carried out only by qualified Mercedes-Benz technicians. Engine adjustments should not be altered in any way. Moreover, the specified service and maintenance jobs must be carried out regularly according to Mercedes-Benz servicing requirements. For details refer to the Maintenance Booklet.

## Warning!

**Inhalation of exhaust gas is hazardous to your health. All exhaust gas contains carbon monoxide, and inhaling it can cause unconsciousness and lead to death.**

**Do not run the engine in confined areas (such as a garage) which are not properly ventilated. If you think that exhaust gas fumes are entering the vehicle while driving, have the cause determined and corrected immediately. If you must drive under these conditions, drive only with at least one window fully open.**

## On-Board Diagnostic System

The Sequential Multiport Fuel Injection (SFI) control module monitors emission control components that either provide input signals to or receive output signals from the control module. Malfunctions resulting from interruptions or failure of any of these components are indicated by the "CHECK ENGINE" malfunction indicator lamp in the instrument cluster and are simultaneously stored in the SFI control module.

If the "CHECK ENGINE" malfunction indicator lamp comes on, have the system checked at your authorized Mercedes-Benz dealer as soon as possible.

An on-board diagnostic connector allows the accurate identification of system malfunctions through the readout of diagnostic trouble codes.

## Traveling Abroad

Abroad, there is a widely-spread Mercedes-Benz service network at your disposal. If you plan to travel into areas which are not listed in the index of your dealer directory, you should request pertinent information from your authorized Mercedes-Benz dealer.

## Winter Driving

Have your car winterized at your authorized Mercedes-Benz dealer before the onset of winter.

- Change the engine oil if the engine contains an oil which is not approved for winter operation. For viscosity (SAE class) and filling quantity, see *Capacities: Fuels, Coolants, Lubricants etc.* in Index.
- Check engine coolant anticorrosion/antifreeze concentration.

- Additive for the windshield washer and headlamp cleaning system: Add MB Concentrate "S" to a premixed windshield washer solvent/antifreeze which is formulated for below freezing temperatures (see Index).
- Test battery: Battery capacity drops with decreasing ambient temperature. A well charged battery ensures that the engine can always be started, even at low ambient temperatures.
- Tires: We recommend M + S radial tires on all four wheels for the winter season. Observe permissible maximum speed for M + S radial tires and the legal speed limit.

Note:

In winter operation, the maximum effectiveness of the electronic stability program can only be achieved with M+S radial-ply tires and/or snow chains recommended by Mercedes-Benz. Snow chains maximize performance.

## Snow Chains

Use only snow chains that are tested and recommended by Mercedes-Benz. Your authorized Mercedes-Benz dealer will be glad to advise you on this subject.

Chains should only be used on the rear wheels. Follow the manufacturer's mounting instructions.

Snow chains should only be driven on snow covered roads at speeds not to exceed 30 mph (50 km/h). Remove chains as soon as possible when driving on roads without snow.

For tips on driving on slippery winter roads, refer to Index.

When driving with snow chains, press the ASR control switch or the ESP control switch, refer to Index.



## **Practical Hints**

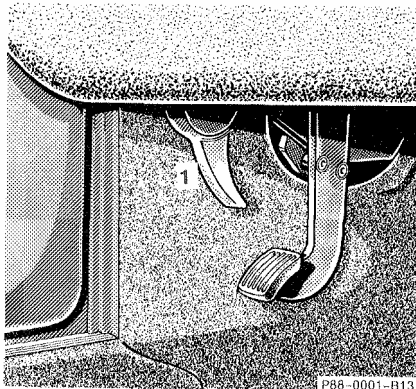

## Hood

To open:

To unlock the hood, pull release lever (1) under the driver's side of the instrument panel. At the same time handle (2) will extend out of the radiator grill (it may be necessary to lift the hood up slightly).

### Caution!

To avoid damage to the windshield wipers or hood, open the hood only with wipers in the parked position.

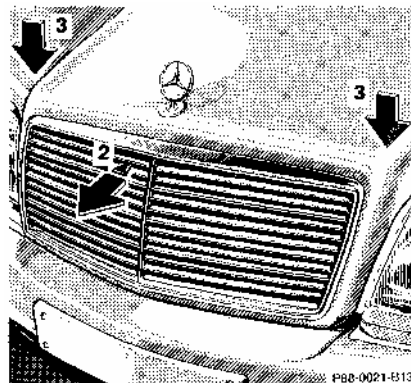

Pull handle (2) out of radiator grill to stop and open hood. Do not lift hood at louvers of grill! Make certain the windshield wiper arm is not folded forward.

To close:

Lower hood and let it drop into lock from a height of approx. 30 cm (1 ft). Do not press down on hood with hands.

To avoid hood damage, if hood is not fully closed, repeat closing procedure.

### Warning!

To help prevent personal injury, stay clear of moving parts when the hood is open and the engine is running. Be sure the hood is properly closed before driving.

The engine is equipped with a transistorized ignition system. Because of the high voltage it is dangerous to touch any components (ignition coil, distributor, spark plug sockets, ignition cables, diagnostic socket) of the ignition system

- with the engine running,
- while starting the engine,
- if the ignition is "on" and the engine is turned manually.

If you see flames, steam or smoke coming from the engine compartment, or if the coolant temperature gauge indicates that the engine is overheated, do not open the hood. Move away from vehicle and, if necessary, call a fire department.



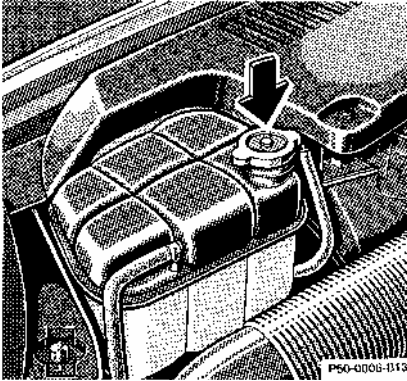

### Checking Coolant Level

To check the coolant level, the vehicle must be parked on level ground and the engine stopped.

Check coolant level only when coolant is cold.

The coolant should reach the top of the tab inside the filler neck.

### Adding Coolant.

If coolant has to be added, a 50/50 mixture of water and MB anticorrosion/antifreeze should be added.

The drain plugs for the cooling system are located on the right and left sides of the engine block and at the bottom of the radiator.

Anticorrosion/antifreeze, see Coolants in Index

### Warning!

**In order to avoid possibly serious burns:**

- **Use extreme caution when opening the hood if there are any signs of steam or coolant leaking from the cooling system, or if the coolant temperature gauge indicates that the coolant is overheated.**

- **Do not remove pressure cap on coolant reservoir if engine temperature is above 90°C (194°F). Allow engine to cool down before removing cap. The coolant reservoir contains hot fluid and is under pressure.**
- **Using a rag, slowly open cap approximately 1/2 turn to relieve excess pressure. If opened immediately, scalding hot fluid and steam will be blown out under pressure.**
- **Do not spill antifreeze on hot engine parts. Antifreeze contains ethylene glycol which may burn if it comes into contact with hot engine parts.**

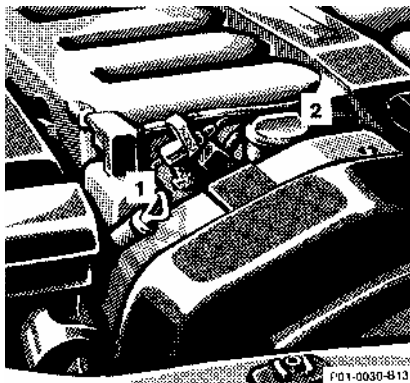

## Checking Engine Oil Level

- 1 Oil dipstick
- 2 Oil filler cap

To check the engine oil level, park vehicle on level ground, with engine at normal operational temperature.

Check engine oil level approximately 5 minutes after stopping the engine, allowing for the oil to return to the oil pan.

Wipe oil dipstick clean prior to checking the engine oil level. Fully insert dipstick in tube, and remove after three seconds to obtain accurate reading.

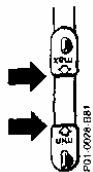

Oil level must be between the lower (min) and upper(max) mark of the dipstick

Fill quantity between upper and lower dipstick marking level is approximately 2.1 US qt (2.0 l).

Do not overfill the engine. Excessive oil must be drained or siphoned. It could cause damage to engine and catalytic converter not covered by the Mercedes-Benz Limited Warranty.

For low engine oil level warning lamp, see Index.

## Automatic Transmission Fluid Level

The transmission has a permanent fill of automatic transmission fluid.

Regular automatic transmission fluid level checks and changes are not required. For this reason the dipstick is omitted.

When noticing fluid loss or gear shifting malfunctions, have your authorized Mercedes-Benz dealer check the transmission fluid level.

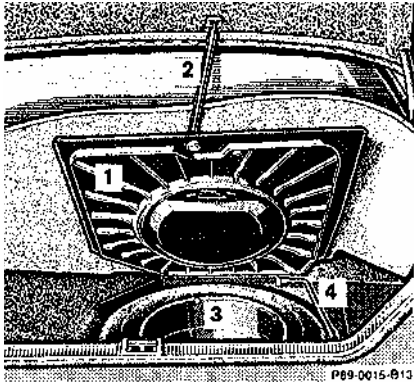

## Spare Wheel

- 1 Trunk floor
- 2 Strap
- 3 Luggage bowl

Roll back the floor mat. Lift the trunk floor (1) and engage strap (2) in the eyelet on the edge of the trunk lid.

To remove the spare tire, turn luggage bowl (3) to the left and remove.

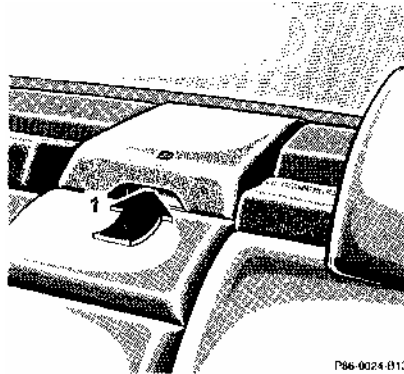

## First Aid Kit

- 1 Opening lid

The first aid kit is stored in the shelf below the rear window.

If the trunk is to remain open for a long period of time, the trunk lamp can be switched off. This prevents the vehicle battery from being discharged.

When the trunk lid is closed, the switch will reset and turn on the lamp next time the lid is opened.

When switching the lamp off, the trunk lid handle also retracts. The handle extends when switching the lamp on.

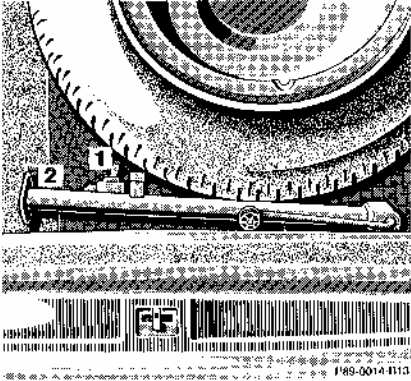

### Vehicle Jack

- 1 Jack arm
- 2 Jack base

See illustration for proper storage of jack.

Before storing the jack on the felt in the spare wheel well, the jack arm must be lowered almost to the base of the jack.

### Warning!

The jack is designed exclusively for jacking up the vehicle at the jack tubes built into either side of the vehicle. Use the jack only to lift the vehicle during a wheel change. Never get beneath the vehicle while it is supported by the jack. Keep hands and feet away from the area under the lifted vehicle. Always firmly set parking brake and block wheels before raising vehicle with jack.

Do not disengage parking brake while the vehicle is raised. Be certain that the jack is always vertical when in use, especially on hills. Always try to use the jack on level surface. Be sure that the jack arm is fully inserted in the jack tube. Always lower the vehicle onto sufficient capacity jackstands before working under the vehicle.

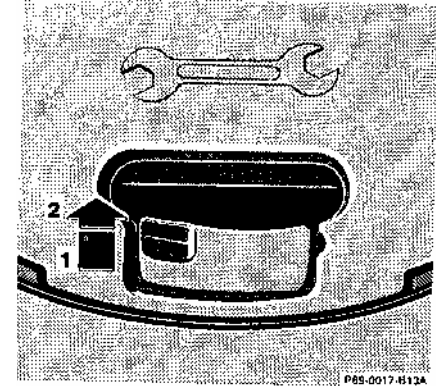

### Vehicle Tools, Storage Compartment below Tool Box

- 1 Lock tool box lid
- 2 Unlock tool box lid

To open the storage compartment:  
Lift out tool box.

To insert the tool box:  
Position rear end of tool box, press down its front end.

## Wheels

Replace rims or tires with the same designation, manufacturer and type as shown on the original part. See your authorized Mercedes-Benz dealer for further information.

See your authorized Mercedes-Benz dealer for information on tested and recommended rims and tires for summer and winter operation. They can also offer advice concerning tire service and purchase.

## Tire Replacement

Front tires should be replaced in sets. Furthermore - in the event of tire replacement - the spare wheel, if possible, should be used on the rear axle. Rims and tires must be of the same size and type. For dimensions, see "Technical Data".

We recommend that you break in new tires for approx. 60 miles (100 km) at moderate speed.

It is imperative that the wheel mounting bolts be fastened to a tightening torque of 110 ft.lb. (150 Nm) whenever wheels are mounted.

For rim and tire specifications, refer to "Technical Data".

## Warning!

**Worn, old tires can cause accidents. If the tire tread is badly worn, or if the tires have sustained damage, replace them.**

**When replacing rims, use only genuine Mercedes-Benz wheel bolts (identified by Mercedes star) specified for the particular rim type. Failure to do so can result in the bolts loosening and possibly an accident.**

## Rotating Wheels

The wheels can be rotated according to the degree of tire wear while retaining the same direction of travel.

Rotating, however, should be carried out at a mileage of 3000 -6000 miles (5000 - 10 000 km), before the characteristic tire wear pattern (shoulder wear on front wheels and tread center wear on rear wheels) becomes visible, as otherwise the driving properties deteriorate.

## Important!

Unidirectional snow tires must always be mounted with arrow on tire sidewall pointing in direction of vehicle forward movement.

Note:

Thoroughly clean the inner side of the wheels any time you rotate the wheels or wash the vehicle underside.

The use of retread tires is not recommended. Retread tires may adversely affect the handling characteristics and safety of the vehicle.

Dented or bent rims can cause tire pressure loss and damage to the tire beads. For this reason, check rims for damage at regular intervals. The rim flanges must be checked for wear before a tire is mounted. Remove burrs, if any. Check and correct tire inflation pressure after rotating the wheels. For *Tire Inflation Pressure* refer to Index.

## Warning!

**The jack is designed exclusively for jacking up the vehicle at the jack tubes built into either side of the vehicle. To help avoid personal injury, use the jack only to lift the vehicle during a wheel change. Never get beneath the vehicle while it is supported by the jack. Keep hands and feet away from the area under the lifted vehicle. Always firmly set parking brake and block wheels before raising vehicle with jack.**

**Do not disengage parking brake while the vehicle is raised. Be certain that the jack is always vertical when in use, especially on hills. Always try to use the jack on level surface. Be sure that the jack arm is fully inserted in the jack tube. Always lower the vehicle onto sufficient capacity jackstands before working under the vehicle.**

## Changing Wheels

Move vehicle to a level area which is a safe distance from the roadway.

1. Set parking brake and turn on hazard warning flasher.
2. Move selector lever to position "P" and turn off engine.
3. Prevent vehicle from rolling away by blocking wheels with wheel chocks (not supplied with vehicle) or sizable wood block or stone. When changing a wheel on a hill, place chocks on the downhill side blocking both wheels of the other axle. On a level road, place one chock in front of and one behind the wheel that is diagonally opposite to the wheel being changed.

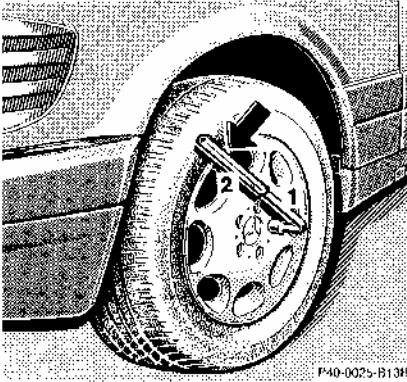

4. Remove lug wrench (1) and extension (2) from tool kit and assemble. Loosen but do not yet remove the wheel bolts.
5. Remove the protective cover from the jack support tube opening by inserting a screw driver in the opening and prying it out.

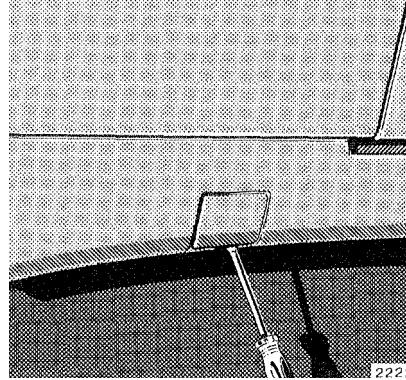

- The tube openings are located directly behind the front wheel housings and in front of the rear wheel housings.
6. Insert jack arm fully into the tube hole up to the stop. Place jack on firm ground. Position the jack so that it is always vertical (plumb-line) as seen from the side (see arrow), even if the vehicle is parked on an incline.

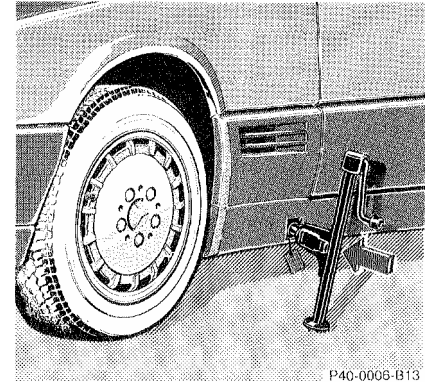

7. Jack up the vehicle until the wheel is clear of the ground. Never start engine while vehicle is raised.
8. Unscrew upper-most wheel bolt and install alignment bolt (1) supplied in the tool kit. Remove the remaining bolts. Keep bolt threads protected from dirt and sand.
9. Remove wheel. Grip wheel from the sides. Keep hands from beneath the wheels.

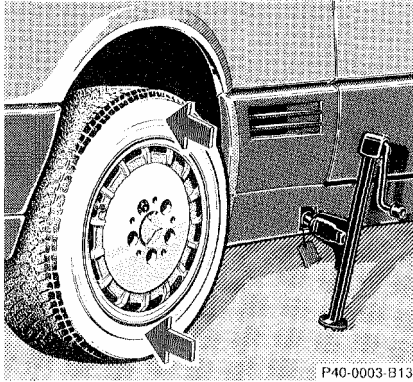

10. Clean contact surfaces of wheel and wheel hub. Install spare wheel on wheel hub. Insert wheel bolts and tighten them slightly.  
To avoid paint damage, place wheel flat against hub and hold it there while installing first wheel bolt.  
Unscrew the alignment bolt (1) to install the last wheel bolt.
11. Lower car. Remove jack and insert jack tube cover.

Before storing the jack, the jack arm must be lowered almost to the base of the jack

### **Warning!**

**Always replace wheel bolts that are damaged or rusted.**

**Never apply oil or grease to wheel bolts.**

**Damaged wheel hub threads should be repaired immediately.**

**Incorrect mounting bolts or improperly tightened mounting bolts can cause the wheel to come off. This could cause an accident. Be sure to use the correct mounting bolts.**

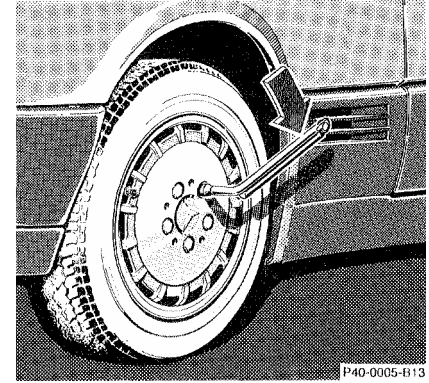

12. Using the wrench, tighten the five bolts evenly, following the sequence illustrated above, until all bolts are tight. Observe a tightening torque of 110 ft.lb. (150 Nm).
13. Correct tire pressure.



## Tire Inflation Pressure

A table (see fuel filler flap) lists the tire inflation pressures specified for summer and winter tires as well as for the varying operating conditions.

### Important!

Tire pressure differs by approx. 0.1 bar (1.5 psi) per 10°C (18°F) of air temperature change. Keep this in mind when checking tire pressure inside a garage especially in the winter.

Example:

If garage temperature = approx. + 20°C (+ 68°F) and ambient temperature = approx. 0°C (+ 32°F) then the adjusted air pressure = specified air pressure + 0.2 bar (+ 3 psi).

Tire pressures listed for light loads are minimum values offering high driving comfort. Increased inflation pressures for heavy loads produce favorable handling characteristics

with lighter loads and are perfectly permissible. The ride of the vehicle, however, will become somewhat harder.

Tire temperature and pressure increase with the vehicle speed. Tire pressure should therefore only be corrected on cold tires. Correct tire pressure in warm tires only if pressure has dropped below the pressure listed in the table and the respective operating conditions are taken into consideration.

An underinflated tire due to a slow leak (e.g. due to a nail in the tire) may cause damage such as tread separation, bulging, etc.. Regular tire pressure checks (including the spare tire) at intervals of no more than 14 days are therefore essential.

If a tire constantly loses air, it should be inspected for damage.

## Warning!

**Do not overinflate tires, Overinflating tires can result in sudden deflation (blow-out) because they are more likely to become punctured or damaged by road debris, potholes, etc. Follow recommended inflation pressures.**

**Do not overload the tires by exceeding the specified vehicle capacity weight (as indicated by the label on the driver's door latch post). Overloading the tires can overheat them, possibly causing a blow-out.**

## Exterior Lamps

### Headlamp Adjustment

Correct headlamp adjustment is extremely important. Check and readjust headlamps at regular intervals and when a bulb has been replaced.

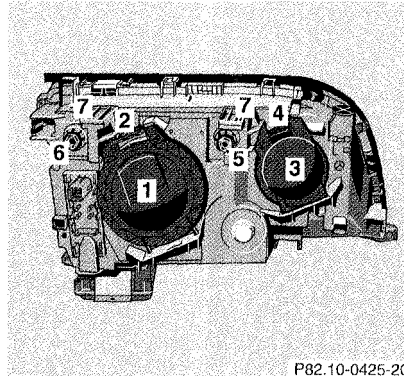

P82.10-0425-20

#### Headlamp Assembly

- 1 Cover for low beam headlamp bulb and fog lamp
- 2 Latch for cover (1)
- 3 Cover for high beam headlamp and level for vertical adjustment
- 4 Latch for cover (3)
- 5 Headlamp vertical adjustment screw

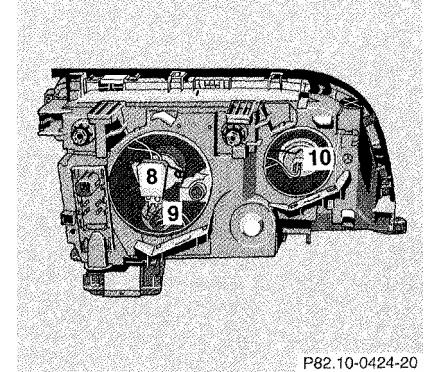

P82.10-0424-20

- 6 Headlamp horizontal adjustment screw
- 7 Scale for horizontal adjustment
- 8 Electrical connector for low beam headlamp bulb
- 9 Electrical connector for fog lamp bulb
- 10 Electrical connector for high beam headlamp bulb

## Replacing bulb:

To prevent a possible electrical short circuit, switch off lamp prior to replacing a bulb.

When replacing bulbs, install only 12 volt bulbs with the specified watt rating.

When replacing halogen bulbs do not touch glass portion of bulb with bare hands. Use plain paper or a clean cloth.

## Warning!

**Halogen lamps contain pressurized gas. A bulb can explode if you:**

- **touch or move it when hot,**
- **drop the bulb,**
- **scratch the bulb.**

## Bulb for Low Beam (Xenon)

### Warning!

**Because of high voltage in Xenon lamps, it is dangerous to replace the bulb or repair the lamp and its components. We recommend that you have such work done by a qualified technician.**

Bulb for High Beam H1 (55 W) Open hood.

Depress latch (4) and remove cover (3).

Pull off electrical connector (10).

Unhook clamping ring and remove bulb.

Insert new bulb (seating properly in cutouts of bulb socket), and mount clamping ring. Reinstall and push electrical connector on securely.

Reinstall bottom end of cover (3) and push against top end of cover until properly seated.

Check lamp for proper operation.

## Bulb for high beam H1 (55 W)

Open hood.

Depress latch (2) and remove cover (1).

Pull off electrical connector (9). Unhook clamping ring and remove bulb.

Insert new bulb (seating properly in cutouts of bulb socket), and mount clamping ring. Reinstall and push electrical connector on securely.

Reinstall bottom end of cover (1) and push against top end of cover until properly seated.

Check lamp for proper operation.

**Turn Signal, Parking, Side Marker  
and Standing Lamp**  
(2357 NA [28.5/8.3 W/30/2.2 cp] bulb)

Open hood.

Squeeze latch (1) together and lift complete lamp assembly out to front of vehicle. Twist bulb socket (2) counterclockwise and pull out. Push bulb into socket, turn counterclockwise and remove.

Insert new bulb in socket, push in and twist clockwise. Reinstall bulb socket. Reinstall lamp assembly by sliding tabs (3) into guides (4) until properly seated.

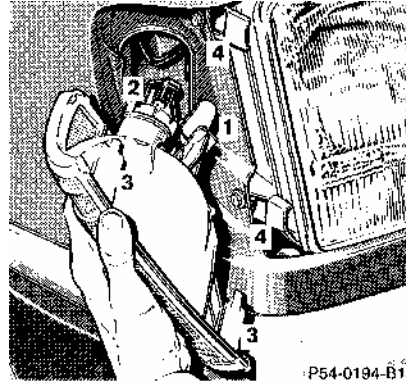

- 1 Latch for turn signal, parking, side marker and standing lamp assembly
- 2 Bulb socket for turn signal, parking, side marker and standing lamp
- 3 Tab
- 4 Guide

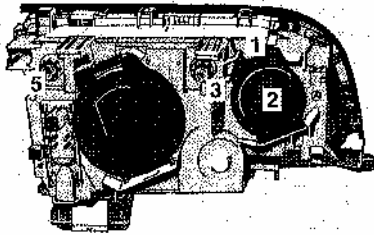

P82-10-0426-20

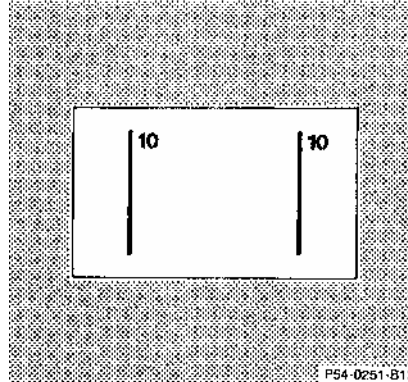

P54-0291-B13

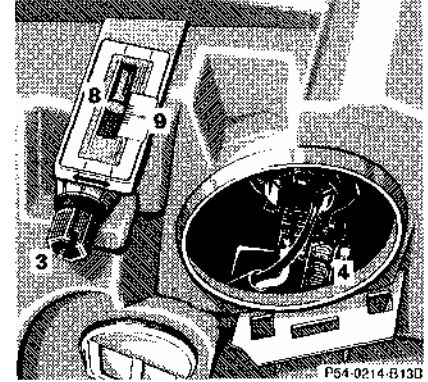

P54-0214-B13D

## Adjusting Headlamp

Correct headlamp adjustment is extremely important. To check and readjust a headlamp do the following:

- Horizontal aim will change and must be corrected as described below, whenever a vertical adjustment is made.
- Adjustments to low beam simultaneously aim the high beam and fog lamp.
- Vehicle should have a normal trunk load.

1. Park vehicle on level surface approximately 6 inches (152 mm) from a vertical test screen or wall. The centerline of the vehicle must be at a 90° angle to the test screen.
2. Using a "T" square and a carpenter's level align and mark a vertical centerline (10) on the test screen using the outer reference point (low beam) found on each headlamp lens. As a check, the distance between centerlines should be 52 <sup>3</sup>/<sub>8</sub> inches (1328 mm).

3. Move vehicle on the level surface 25 feet (7.6 m) straight back from the wall.
4. Open hood, depress latch (1) and remove access cover (2) from the headlamp.
5. Turn key in steering lock to position 2.
6. Vertical headlamp aim (low beams on): Turn adjusting screw (3) (counterclockwise to adjust headlamp downward, clockwise upward) until bubble in the level (4) is centered on the "0" mark.

Graduations: 0.18° pitch.

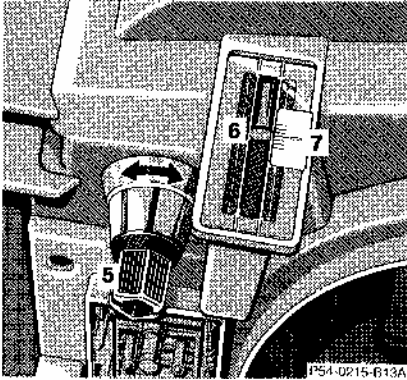

7. Horizontal headlamp aim (low beams on):

Turn adjusting screw (5) (Right front headlamp: counterclockwise to adjust to the left, clockwise to the right; left front headlamp: counterclockwise to adjust to the right, clockwise to the left.) until the headlamps (low beam) illuminate the test screen as shown. The vertex of the angle formed in each beam image should align with the vertical centerline (10) of each lamp.

The left and right headlamps must be adjusted individually.

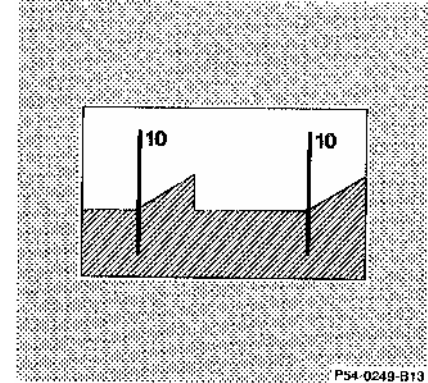

8. The indicator (6 and 8) in the sight glass should align with the "0" mark after any horizontal adjustment. If it does not, slide the "0" mark on the scale (7 and 9) until it aligns with the indicator (6 and 8).

Graduations: 0.38° pitch.

9. Reinstall access cover (2).

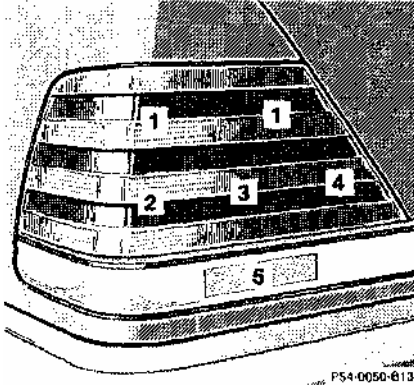

P54-0050-B13

### Taillamp Assemblies

- 1 Turn signal lamp  
(21 W/24 cp bulb)
- 2 Stop, side marker lamp  
(21/5 W/32/2 cp bulb)
- 3 Tail, parking, standing lamp  
(5 W/4 cp bulb)
- 4 Driver's side: Rear fog lamp  
(21 W/32 cp bulb)
- 5 Backup lamp  
(21 W/32 cp bulb)

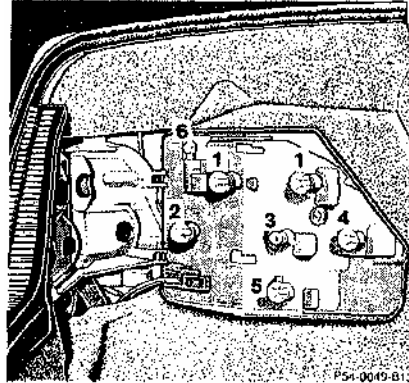

P54-0049-B13

- 6 Trunk lamp (10 W/6 cp bulb)
- 7 Cover

To replace bulbs:

Open trunk lid. Swing cover (7) aside. Twist bulb socket counterclockwise and pull out. Push bulb into socket, turn counterclockwise and remove.

Insert new bulb in socket, push in and twist clockwise. Reinstall bulb socket.

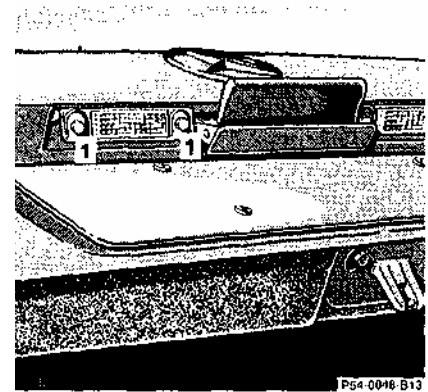

P54-0046-B13

### License Plate Lamps (5 W bulb)

Loosen both securing screws (1), remove lamp and take out bulb.

## Battery

### Warning!

**Failure to follow these instructions can result in severe injury or death. Never lean over batteries while connecting, you might get injured.**

**Battery fluid contains sulfuric acid. Do not allow this fluid to come in contact with eyes, skin or clothing. In case it does, immediately flush affected area with water and seek medical help if necessary.**

**A battery will also produce hydrogen gas, which is flammable and explosive. Keep flames or sparks away from battery, avoid improper connection of jumper cables, smoking etc..**

The maintenance-free battery is located in the trunk under the right-hand wheel well cover panel.

The service life of the battery is dependent on its condition of charge. The battery should always be kept sufficiently charged, in order to last an optimum length of time.

**Therefore, we strongly recommend that you have the battery charge checked frequently, and corrected if necessary, especially if you use the vehicle less than approximately 200 miles (300 km) per month, mostly for short distance trips, or if it is not used for long periods of time.**

Only charge a battery with a battery charger after the battery has been disconnected from the vehicle electrical circuit.

Always disconnect the battery negative lead first and connect last.

When removing and connecting the battery, always make sure that all electrical consumers are off and the key is in steering lock position 0. The battery and its vent tube must always be securely installed when the car is in operation.

While the engine is running the battery terminal clamps must not be loosened or detached, otherwise the generator and other electronic components would be damaged.

Note:

After reconnecting the battery also resynchronize the Express feature of the power windows and the Adaptive Damping System (ADS) (see *Power Windows* and ADS in Index).

### Battery Recycling

Batteries contain materials that can harm the environment with improper disposal.

Large 12 Volt storage batteries contain lead.

Recycling of batteries is the preferred method of disposal.

Many states require sellers of batteries to accept old batteries for recycling.



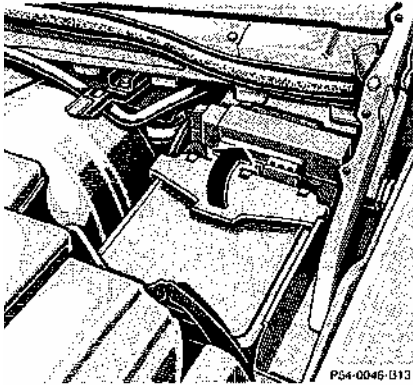

Main fuse box in engine compartment

### Fuses

Before replacing a blown fuse, determine the cause of the short circuit.

Spare fuses are supplied inside the main fuse box. Observe amperage and color of fuse.

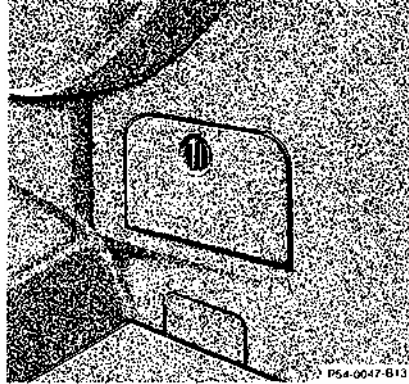

Auxiliary fuse box in trunk behind right side cover

Always use a new fuse for replacement. Never attempt to repair or bridge a blown fuse.

After replacing a blown fuse, close fuse box cover.

### Jump Starting

#### Warning!

Failure to follow these directions will cause damage to the electronic components, and can lead to a battery explosion and personal injury.

Never lean over batteries while connecting or jump starting, you might get injured.

Battery fluid contains sulfuric acid. Do not allow this fluid to come in contact with eyes, skin or clothing. In case it does, immediately flush affected area with water, and seek medical help if necessary.

A battery will also produce hydrogen gas, which is flammable and very explosive. Keep flames or sparks away from battery, avoid improper connection of jumper cables, smoking etc..

Read all instructions before proceeding.

If the battery is discharged, the engine should be started with jumper cables and the (12V) battery of another vehicle.

The battery is located in the trunk behind the right-hand cover panel.

Proceed as follows:

1. Position the vehicle with the charged battery so that the jumper cables will reach, but never let the vehicles touch. Make sure the jumper cables do not have loose or missing insulation.
2. On both vehicles:
  - Turn off engine and all lights and accessories, except hazard warning flashers or work lights.
  - Apply parking brake and shift selector lever to position "P".

### **Important!**

3. Clamp one end of the first jumper cable to the positive (+) terminal of the discharged battery and the other end to the positive (+) terminal of the charged battery. Make sure the cable clamps do not touch any other metal parts.
4. Clamp one end of the second jumper cable to the grounded negative (-) terminal of the charged battery and the final connection to the negative (-) terminal of the discharged battery.

### **Important!**

5. Start engine of the vehicle with the charged battery and run at high idle. Make sure the cables are not on or near pulleys, fans, or other parts that will move when the engine is started. Then start engine of the disabled vehicle in the usual manner.

6. After the engine has started, remove jumper cables by exactly reversing the above installation sequence, starting with the last connection made first. When removing each clamp, make sure that it does not touch any other metal while the other end is still attached.

### **Important!**

A discharged battery can freeze at approx. +14°F (-10°C). In that case, it must be thawed out before jumper cables are used. A frozen battery can explode and cause personal injury.

Jumper cable specifications:

- Minimum cable cross-section of 25 mm<sup>2</sup> or approx. 2 AWG
- Maximum length of 11.5 ft. (3.5 m).

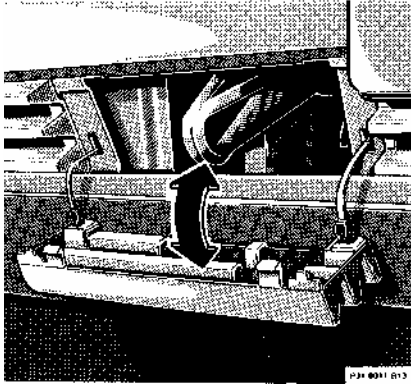

### Towing the Vehicle

The rear towing eye is located at the right, below the bumper. The front towing eye is located on the passenger side behind a flap in the bumper panel.

Flap removal: Insert finger in recess of flap and pull flap out.

Flap installation: Engage flap at bottom and press in top securely.

### Caution!

If the vehicle is towed with the front axle raised, the engine must be shut off. Otherwise, the ASR or ESP will immediately be engaged and will apply the rear wheel brakes.

### Warning!

**With the engine not running, there is no power assistance for the braking and steering systems. In this case, it is important to keep in mind that a considerably higher degree of effort is necessary to brakes and steer the vehicle.**

We recommend that the vehicle be transported using flat bed equipment. This method is preferable to other types of towing.

The vehicle may be towed with all wheels on the ground and the selector lever in position "N" for distances up to 30 miles (50 km) and at a speed not to exceed 30 mph (50 km/h). The key must be in steering lock position 2.

To positively avoid a possibility of damage to the transmission, however, we recommend to disconnect the drive shaft at the rear axle drive flange on any towing beyond a short tow to a nearby garage.

Do not tow with sling-type equipment. Towing with sling-type equipment over bumpy roads will damage radiator and supports.

Use wheel lift, dolly, or flat bed equipment, with key in steering lock turned to position 0.

Note:

To signal turns while being towed with hazard warning flasher in use, turn key in steering lock to position 2 and activate combination switch for left or right turn signal in usual manner - only the selected turn signal will operate.

Upon canceling the turn signal, the hazard flasher will operate again.

## Cleaning and Care of the Vehicle

### Warning!

**Many cleaning products can be hazardous. Some are poisonous, others are flammable. Always follow the instructions on the particular container. Always open your car's doors or windows when cleaning the inside.**

**Never use fluids or solvents that are not designed for cleaning your car.**

In operation, your vehicle is subjected to varying external influences which, if gone unchecked, can attack the paint-work as well as the underbody and cause lasting damage.

Such damage is caused not only by extreme and varying climatic conditions, but also by air pollution, road salt, tar, gravel and stone chipping. Grease and oil, fuel, coolant, brake fluid, bird droppings, tree resins etc. should be removed immediately to avoid paint damage. Frequent washing, however, reduces and/or eliminates the aggressiveness and potency of the above adverse influences.

More frequent washings are necessary to deal with unfavorable conditions; for example, near the ocean, in industrial areas (smoke, exhaust emissions), or during winter operation.

You should check your vehicle from time to time for stone chipping or other damage. Any damage should be repaired as soon as possible to prevent the start of corrosion.

In doing so, do not neglect the underside of the car. A prerequisite for a thorough check is a washing of the underbody followed by a thorough inspection. Damaged areas need to be re-undercoated.

Your vehicle has been treated at the factory with a wax-base rust-proofing in the body cavities which will last for the lifetime of the vehicle. Post-production treatment is neither necessary nor recommended by Mercedes-Benz because of the possibility of incompatibility between materials used in the production process and others applied later.

We have selected car care products and compiled recommendations which are specially matched to our vehicles and which always reflect the latest technology. You can obtain Mercedes-Benz approved, car care products at your authorized Mercedes-Benz dealer.

Scratches, corrosive deposits, corrosion or damage due to negligent or incorrect care cannot always be removed or repaired with the car care products recommended here. In such cases it is best to seek aid at your authorized Mercedes-Benz dealer.

The following topics deal with the cleaning and care of your vehicle and give important "how-to" information as well as references to Mercedes-Benz approved car care products.

Additional information can be found in the booklet titled "Car Care".

## **Engine Cleaning**

Prior to cleaning the engine compartment make sure to protect electrical components and connectors from the intrusion of water or cleaning agents.

Corrosion protection, such as MB Anticorrosion Wax should be applied to the engine compartment after every engine cleaning. Before applying, all control linkage bushings and joints should be lubricated. The poly-V-belt and all pulleys should be protected from any wax.

## **Car Washing**

Before washing your vehicle, remove insect residues. MB Insect Remover is recommended. Do not use hot water or wash your car in direct sunlight. Use only a mild car wash detergent, such as MB Autoshampoo.

Thoroughly spray the car with a diffused jet of water. Direct only a very weak spray towards the ventilation intake.

Use plenty of water and rinse the sponge and chamois frequently.

Rinse with clear water and thoroughly wipe dry with a chamois. Do not allow cleaning agents to dry on the finish. Before running the vehicle through an automatic car wash, fold back the outside mirrors to prevent them from getting damaged.

If the vehicle has been run through an automatic car wash -in particular one of the older installations - rewipe the recessed sections in the taillamps (designed to prevent soiling) if necessary. No solvents (fuels, thinners etc.) must be used.

In the winter, thoroughly remove all traces of road salt as soon as possible.

When washing the underbody, do not forget to clean the inner sides of the wheels.

## **Tar Stains**

Quickly remove tar stains before they dry and become more difficult to remove. MB Tar Remover is recommended.

## **Window Cleaning**

Use a window cleaning solution on all glass surfaces. MB Glass Cleaner is recommended.

## **Wiper Blades**

Clean the wiper blade rubber with a clean cloth and detergent solution. Replace blades twice a year; once before and once after winter.

## **Headlamp Cleaning System**

The condition of the wiper blades is important for satisfactory cleaning of the headlamp lenses. We therefore recommend that the blades be inspected regularly.

Replace damaged wiper blades.

### **Plastic Parts, Headliner and Rubber Parts**

Do not use oil or wax on these parts. See separate subject for additional information.

### **Seat Belts**

The webbing must not be treated with chemical cleaning agents. Use only clear, lukewarm water and soap. Do not dry the webbing at temperatures above 176°F (80°C) or in direct sunlight.

### **Warning!**

**Do not bleach or dye seat belts as this may severely weaken them. In a crash they may not be able to provide adequate protection.**

### **Instrument Cluster**

Use a gentle dish-washing detergent or mild detergent for delicate fabrics as a washing solution. Wipe with a cloth moistened in lukewarm solution. Do not use scouring agents.

### **Steering Wheel and Gear Selector Lever**

Wipe with a damp cloth and dry thoroughly or clean with Mercedes-Benz approved Leather Care.

### **Hard Plastic Trim Items**

Pour Mercedes-Benz approved Interior Care onto soft lint-free cloth and apply with light pressure.

### **Headliner and Shelf below Rear Window**

Clean with soft bristle brush, or use a dry-shampoo cleaner in case of excessive dirt.

### **Leather Upholstery**

Using aftermarket seat covers or wearing clothing that have the tendency to give off coloring (e.g. when wet etc.) may cause the upholstery to become permanently discolored. By lining the seats with a proper intermediate cover, contact-discoloration will be prevented.

Wipe leather upholstery with a damp cloth and dry thoroughly or clean with Mercedes-Benz approved Leather Care. Exercise particular care when cleaning perforated leather as its underside should not become wet.

### **Paintwork, Painted Body Components**

Mercedes-Benz approved Paint Care should be applied when water drops on the paint surface do not "bead up"; normally in 3 to 5 months, depending on climate and washing detergent used.

Mercedes-Benz approved Paint Cleaner should be applied if paint surface shows signs of dirt embedding (i.e. loss of gloss).

Do not apply any of these products or wax if your car is parked in the sun or if the hood is still hot.

Use the appropriate MB-Touch-Up Stick for quick and provisional repairs of minor paint damage (i.e. chips from stones, car doors etc.).

### **Light Alloy Wheels**

Mercedes-Benz approved Wheel Care should be used for regular cleaning of the light alloy wheels.

If possible, clean wheels once a week with Mercedes-Benz approved Wheel Care using a soft bristle brush and a strong spray of water.

Follow instructions on container.

Note:

Use only acid-free cleaning materials. The acid could lead to corrosion.

### **Ornamental Moldings**



For regular cleaning and care of very dirty chrome-plated parts, use a chrome cleaner.

### **Automatic Antenna**

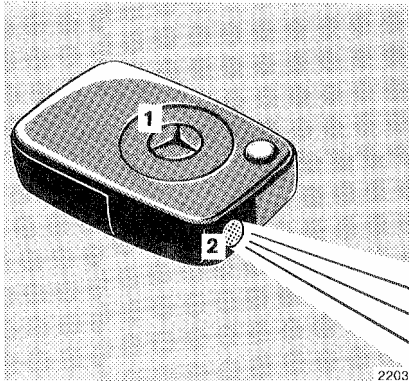
For trouble-free operation of the automatic antenna and rear fender indicators, we recommend that you clean them periodically.



### Testing Remote Control Checking Batteries:

If transmit button  or  is pressed longer than 1 second, the battery indicator lamp in the transmitter eye (1) briefly illuminates -indicating that the batteries are in order.

Change batteries if the indicator lamp does not come on.

### Changing Batteries:

Unfold key from holder by pressing lock button (2). Pull off battery cover (3).

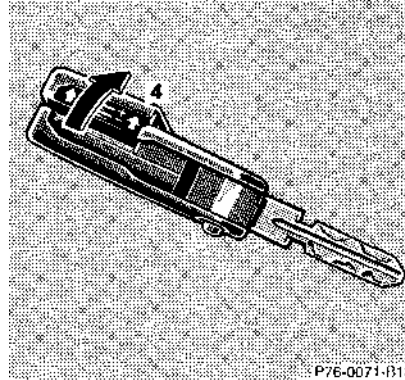

Change batteries, inserting new ones with plus (+) side facing up.

Press battery cover onto housing until locked in place.

### Important!

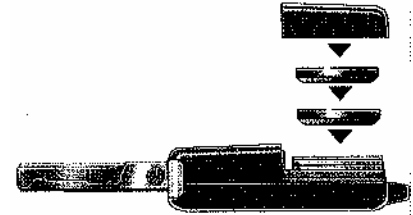

Batteries contain materials that can harm the environment if disposed of improperly. Recycling of batteries is the preferred method of disposal. For disposal, please follow manufacturer's recommendation on battery package.

Replacement battery:  
Lithium, type CR 2025 or equivalent.



P60.30-0296-20

### Synchronizing System:

To synchronize system, aim transmitter eye (1) at vehicle and briefly press transmit button  or  twice. Within approx. 30 seconds, insert key in steering lock and turn it to position 2.

The remote control should once again be operational.



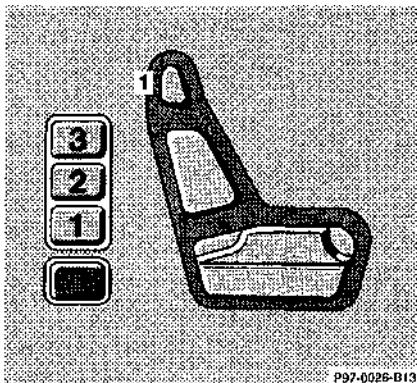

## Front Head Restraints

### Removal:

Push button (1) up to bring the head restraint to its highest position.

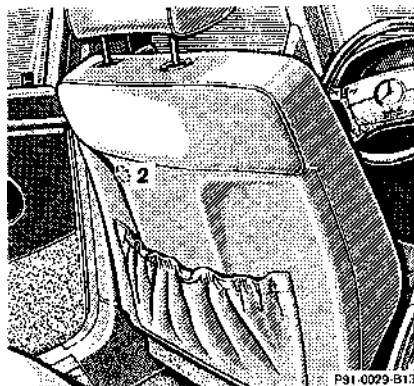

Depress release button (2) beneath the seatback covering material and pull head restraint up sharply, holding it by the left head restraint post (viewed in driving direction).

Pull out head restraint completely with both hands.

### Installation:

Push button (1) up for approximately 5 seconds.

Insert the head restraint and push it down to the stop.

Adjust head restraint to the desired position.

### Warning!

**For your protection, drive only with properly positioned head restraints.**

**Do not drive the vehicle without the seat head restraints. Head restraints are intended to help reduce injuries during an accident.**

For positioning of head restraints refer to sections *Power Seats, Front*, and *Head Restraints, Rear* in Index.

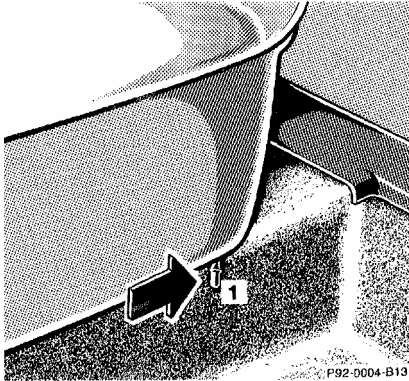

### **Rear Bench Seat Cushion**

**Removal:** Push in locking tabs (1) (on left and right side of seat) and pull up seat at the front.

**Installation:** Slide rear edge of cushion under the backrest. Push front of cushion down until it locks in place.

### **Caution!**

Watch out for sharp edges when removing or installing the rear seat cushion, and make sure that it is securely locked in place again, to prevent personal injury.

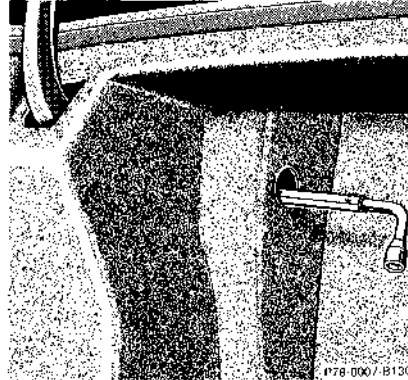

### **Emergency Operation of Sliding/Pop-Up Roof**

The sliding roof can be opened or closed manually should an electrical malfunction occur.

Assemble the lug wrench and extension (from tool kit). Insert extension through opening in panel and place on the hex-drive of the electric motor. Turn lug wrench (manually) to open or close roof as desired.

To slide the roof closed or to raise the roof at the rear: turn clockwise.

To slide the roof open or to lower the roof at the rear: turn counterclockwise.

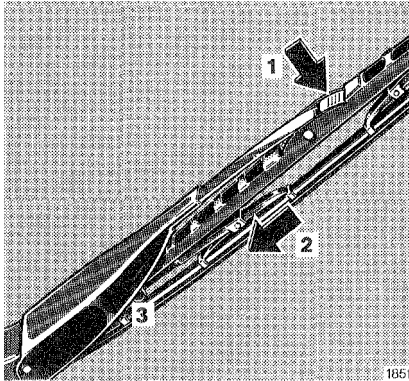

### Replacing Wiper Blades

For safety reasons, remove key from steering lock before replacing a wiper blade, otherwise the motor can suddenly turn on and cause injury.

### Windshield Wiper Blades

Removal:

Pull wiper blade arms upward from the rest position to their stop.

Replace wiper blades one at a time to prevent the wiper arms from sliding back to the rest position.

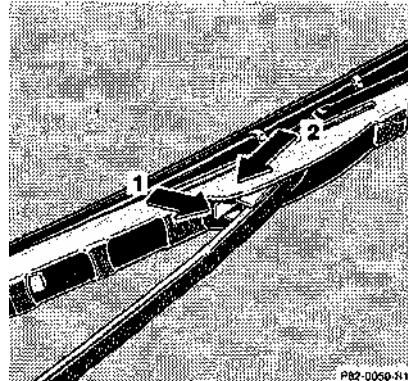

Fold wiper arm forward. Press safety tab down (1), push wiper blade downward (2) and remove.

Installation - driver's side:

Press safety tab of new wiper blade down. Insert wiper blade between the tabs (3) on the wiper arm and slide into end of wiper arm. Then press safety tab upward until it locks in place.

Installation - passenger side:

Fold wiper arm forward and slide wiper blade into end of wiper arm until safety tab locks in place.

Note:

Do not open engine hood with wiper arms folded forward.

Do not allow wiper arms to contact the windshield glass without wiper blades inserted. The glass may be scratched or broken.

Make certain that the wiper blade is properly installed. An improperly installed blade may cause windshield damage.

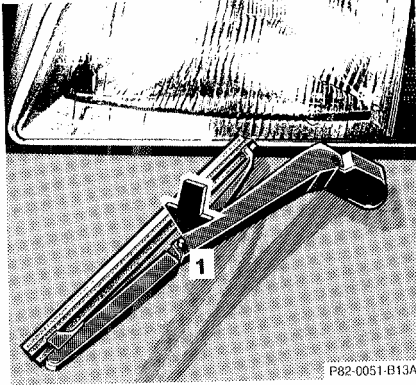

## Headlamp Wiper Blades

Removal:

Fold wiper arm forward. Push pin (1) and remove wiper blade.

Installation;

Place wiper blade on wiper arm and press in pin (1).

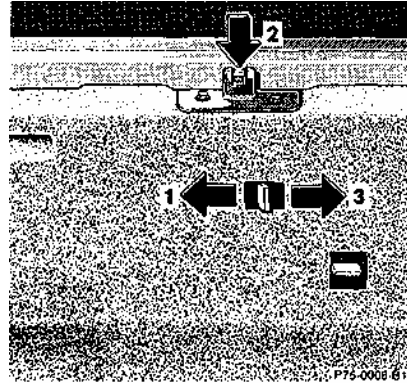

## Manual Closing of Trunk Lid

The trunk lid can be closed manually should a malfunction occur on the power closing system.

With the trunk lid open:

push sliding switch to position (1),

press eye of latch in (2),

push sliding switch to position (3).

Close trunk lid.

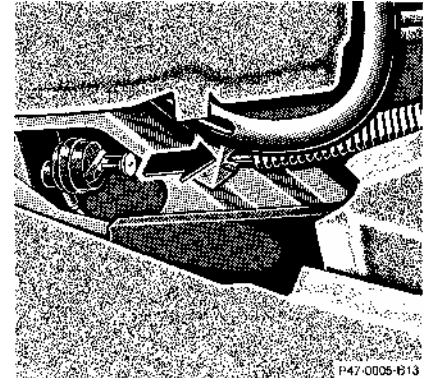

## Manual Release of Fuel Filler Flap

The manual release knob is located behind the right side trunk panel and felt pad.

In case the central locking system does not release the fuel filler flap, pull the manual release knob while simultaneously opening the fuel filler flap.

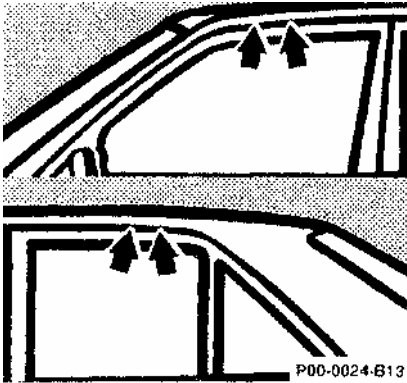

### Roof Flack

Use only those roof racks approved by Mercedes-Benz to avoid damage to the vehicle. Follow manufacturer's installation instructions.

Mount supports only between markings on border of roof which are visible when doors are opened.

### Spare Parts Service

All authorized Mercedes-Benz dealers maintain a stock of original spare parts required for maintenance and repair work. In addition, strategically located parts distribution centers provide quick and reliable parts service.

More than 300,000 different spare parts, even for older models, are available.

Mercedes-Benz original spare parts are subjected to the most stringent quality inspections. Each part has been specifically developed, manufactured or selected for and adapted to Mercedes-Benz vehicles.

Therefore, Mercedes-Benz original spare parts should be installed.

### Important!

The use of non-genuine parts and accessories not authorized by Mercedes-Benz could damage the vehicle or compromise its durability or safety.

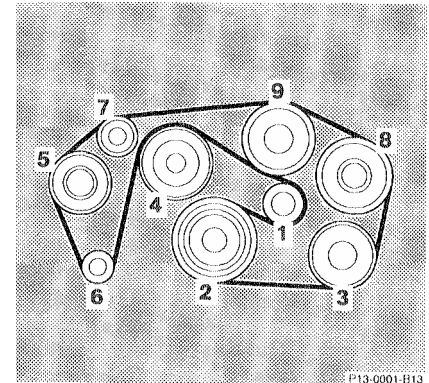

### Layout of Poly-V-belt Drive

- 1 Automatic belt tensioner
- 2 Crankshaft
- 3 Air conditioning compressor
- 4 Fan
- 5 Air pump
- 6 Generator (alternator)
- 7 Idler pulley
- 8 Power steering pump
- 9 Coolant pump

For dimensions of the poly-V-belt, see *Technical Data* in Index.



## **Technical Data**

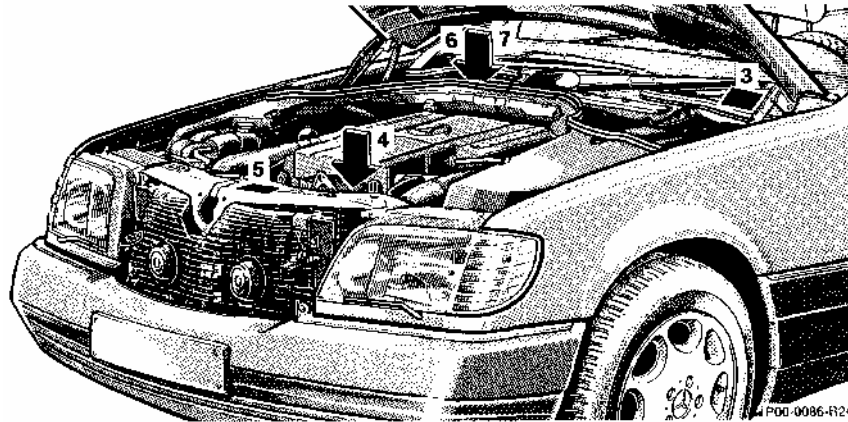
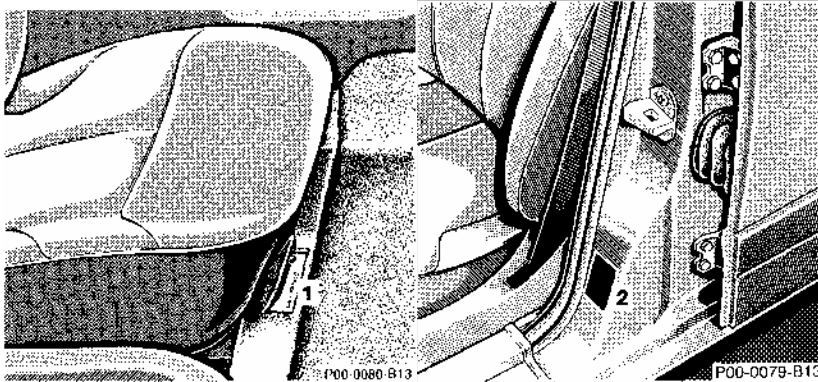

## Identification Plates

When ordering spare parts, please specify vehicle identification and engine numbers.

- 1 Vehicle Identification No.
- 2 Certification Tag
- 3 Identification Tag  
(lower edge of windshield)
- 4 Engine No.
- 5 Body No. and Paintwork No.
- 6 Emission Control Tag
- 7 Information Tag  
California version  
Vacuum line routing for  
emission control system



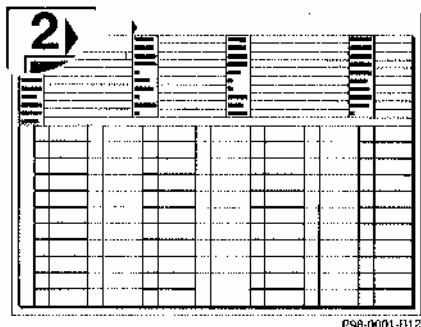

### Vehicle Data Card

The vehicle data card contains all important data pertaining to the vehicle. It should be kept in the maintenance booklet where indicated, and it is needed when obtaining replacement or additional keys at your authorized Mercedes-Benz dealer.

### Warranty Coverage

Your car is covered under the terms of the "warranties" printed in the Owner's Service and Warranty Policy Booklet and your authorized MERCEDES-BENZ dealer will exchange or repair any defective parts in accordance with the terms of the following warranties:

1. New vehicle limited warranty
2. Emission systems warranty
3. Emission performance warranty
4. California emission control systems warranty

### Loss of Owner's Service and Warranty Policy

Should you lose your Owner's Service and Warranty Policy Booklet, have your authorized MERCEDES-BENZ dealer arrange for a replacement. It will be mailed to you.

## Technical Data

Model	S 600 (140 057) <sup>1</sup>
<b>Engine</b>	120
Mode of operation	4-stroke engine, gasoline injection
No. of cylinders	12
Bore	89.00 mm (3.50 in)
Stroke	80.20 mm (3.16 in)
Total piston displacement	5987 m <sup>3</sup> (365.4 cu.in)
Compression ratio	10:1
Output acc.to SAE J 1349	290 kW/5200rpm (389 hp/5200 rpm)
Maximum torque acc. to SAE J 1349	570 Nm/3800 rpm (421 ft-lb/3800 rpm)
Maximum engine speed	6000 rpm
Firing order	1-12-5-8-3-10-6-7-2- 11-4-9
Poly – V - belts length	2585 mm

## Rims – Tires

Rims (light alloy rims)	7 1/2 J x 16 H 2
Wheel offset	51 mm (2.0 in)
Summer tires: Radial-ply tires	235/60 ZR 16
Winter tires: Radial-ply tires	235/55 R16 100H M+S

## Electrical System

Generator (alternator)	14 V/143A
Starter motor	12 V/2.2 kW
Battery	12 V/100 Ah
Spark plugs	Bosch F 9 DCO Beru 14 F-9 DUO Champion C 10 YCC
Electrode gap	0.8 mm (0.032 in)
Tightening torque	15-22 ft.lb. (20-30 Nm)

<sup>1</sup> The quoted data apply only to the standard vehicle. See an authorized Mercedes-Benz dealer for the corresponding data of all special bodies and special equipment.

## Technical Data

### Weights

See certification tag

Roof load max.	100 kg (220 lb)
Trunk load max.	100 kg (220 lb)

### Main Dimensions

Overall vehicle length	5213 mm (205.2 in)
Overall vehicle width	1886 mm ( 74.3 in)
Overall height:	1482 mm ( 58.3 in)
Wheel base	3140 mm (123.6 in)
Track, front	1606 mm ( 63.2 in)
Track, rear	1579 mm ( 62.2 in)

## Fuels, Coolants, Lubricants etc. - Capacities

Vehicle components and their respective lubricants must match.

Therefore use only brands tested and recommended by us.

Inquire at your authorized Mercedes-Benz dealer.

	Capacity	Fuels, coolants, lubricants etc.
Engine with oil filter	10.0 l (10.0 US qt)	Recommended engine oils
Automatic transmission	9.4 l (9.9 US qt)	Automatic transmission fluid
Rear axle	1.4 l (1.5 US qt)	Hypoid gear oil SAE 90, 85 W 90
Hydraulic system for adaptive damping system (ADS)	approx. 2.1 US qt (2.0 l)	MB Hydraulic fluid
Power steering	approx. 1.4 US qt (1.3 l)	MB Power steering fluid
Front wheel hubs	approx. 2.1 oz (60 g) each	High temperature roller bearing grease
Accelerator control linkage		Hydraulic fluid
Brake system	approx. 0.7 US qt (0.7 l)	MB Brake fluid (DOT 4)

	Capacity	Fuels, coolants, lubricants etc.
Windshield washer and headlamp cleaning system	approx. 5.3 US qt (5.0 l)	MB Windshield washer concentrate "S" <sup>1</sup>
Cooling system	approx. 16.4 US qt (15.5 l)	MB Anticorrosion/antifreeze
Fuel tank including a reserve of	approx. 26.4 US gal (100 l) approx. 3.3 US gal (12.5 l)	Premium unleaded gasoline: Posted Octane 91 (Average of 96 RON/86 MON)
Air conditioner system		R-134a refrigerant and special lubricant( <i>Never R-12</i> ) (selected vehicles - see underhood label)

<sup>1</sup> Use MB Windshield Washer Concentrate "S" and water for temperatures above freezing or MB Windshield Washer Concentrate "S" and commercially available premixed windshield washer solvent/antifreeze for temperatures below freezing. Follow suggested mixing ratios, see *Windshield/Headlamp Washer System* in Index.

## Engine Oils

Engine oils are specifically tested for their suitability in our engines. Therefore, use only engine oils recommended by Mercedes-Benz. Information on recommended brands is available at your authorized Mercedes-Benz dealer.

Please follow maintenance booklet recommendations for scheduled oil changes. Failure to do so could result in engine damage not covered by the Mercedes-Benz Limited Warranty

## Engine Oil Additives

Do not blend oil additives with engine oil. They may be harmful to the engine operation.

Damage or malfunctions resulting from blending oil additives are not covered by the Mercedes-Benz Limited Warranty.

## Air Conditioner Refrigerant

Ozone-friendly HFC-134a refrigerant and special lubricating oil is used in the air conditioner system.

Never use R-12 (CFC) or mineral-based lubricating oil, otherwise damage to the system will occur.

## Brake Fluid

During vehicle operation, the boiling point of the brake fluid is continuously reduced through the absorption of moisture from the atmosphere. Under extremely hard operating conditions, this moisture content can lead to the formation of bubbles in the system thus reducing the system's efficiency.

The brake fluid must therefore be replaced every two years, preferably in the spring.

It is recommended to use only brake fluid approved by Mercedes-Benz. Your authorized Mercedes-Benz dealer will provide you with additional information.

## Premium Unleaded Gasoline

### Caution!

To maintain the engine's durability and performance, premium unleaded gasoline must be used. If premium unleaded is not available and low octane fuel is used, follow these precautions:

- have the fuel tank filled only partially with unleaded regular and fill up with premium unleaded as soon as possible,
- avoid full throttle driving and abrupt acceleration,
- do not exceed an engine speed of 3000 rpm, if the vehicle is loaded with a light load such as two persons and no luggage,
- do not exceed  $\frac{2}{3}$  of maximum accelerator pedal position, if the vehicle is fully loaded or operating in mountainous terrain.

## **Fuel Requirements**

Use only Premium unleaded meeting ASTM standard D 439:

The octane number (posted at the pump) must be 91min. It is an average of both, the Research (R) octane number and the Motor (M) octane number:  $[(R + M)/2]$ . This is also known as ANTI-KNOCK INDEX.

Unleaded gasoline containing oxygenates such as Ethanol, I PA, IBA and TBA can be used provided the ratio of any one of these oxygenates to gasoline does not exceed 10%, MTBE not to exceed 15%.

The ratio of Methanol to gasoline must not exceed 3% plus additional cosolvents.

Using mixtures of Ethanol and Methanol is not allowed. Gasohol, which contains 10% Ethanol and 90% unleaded gasoline, can be used.

These blends must also meet all other fuel requirements such as resistance to spark knock, boiling range, vapor pressure etc..

## **Gasoline Additives**

A major concern among engine manufacturers is carbon build up caused by gasoline. Mercedes-Benz recommends to use only quality gasoline containing additives that prevent the build up of carbon deposits.

After an extended period of using fuels without such additives, carbon deposits can build up especially on the intake valves and in the combustion area, leading to engine performance problems such as:

- warm-up hesitation,
- unstable idle,
- knocking/pinging,
- misfire,
- power loss.

Do not blend other specific fuel additives with fuel. They only result in unnecessary cost, and may be harmful to the engine operation.

Damage or malfunctions resulting from poor fuel quality or from blending specific fuel additives are not covered by the Mercedes-Benz Limited Warranty.

## Coolants

The engine coolant is a mixture of water and anticorrosion/anti-freeze, which provides:

- corrosion protection
- freeze protection
- boiling protection (by increasing the boiling point).

The cooling system was filled at the factory with a coolant providing freeze protection to approx. -22 °F (-30 °C) and corrosion protection.

The coolant solution must be used year round to provide the necessary corrosion protection and increase in the boil-over protection. You should have it replaced every 3 years.

To provide the important corrosion protection, the solution must be at least 45% anticorrosion/antifreeze (equals a freeze protection to approx. -22 °F [-30 °C]). If you use a solution that is more than 55% anticorrosion/antifreeze (freeze protection to approx. -49 °F [-45°C]), the engine temperature will increase due to the lower

Heat transfer capability of the solution. Therefore, do not use more than this amount of anti-corrosion/antifreeze.

If the coolant level is low, water and MB anticorrosion/antifreeze should be used to bring it up to the proper level (have cooling system checked for signs of leakage).

The water in the cooling system must meet minimum requirements, which are usually satisfied by normal drinking water. If you are not sure about the water quality, consult your authorized Mercedes-Benz dealer.

### Anticorrosion/antifreeze

Your vehicle contains a number of aluminum parts. The use of aluminum components in motor vehicle engines necessitates that anticorrosion/antifreeze coolant used in such engines be specifically formulated to protect the aluminum parts. (Failure to use such anticorrosion/antifreeze coolant will result in a significantly shortened service life.)

Therefore the following product is strongly recommended for use in your car: Mercedes-Benz Anticorrosion/Antifreeze Agent.

Before the start of the winter season (or once a year in the hot southern regions), you should have the anticorrosion/antifreeze concentration checked. The coolant is also regularly checked each time you bring your vehicle to your authorized Mercedes-Benz dealer for maintenance service.

### Anticorrosion/antifreeze quantity

Approx. freeze	Anticorrosion /antifreeze
-35 °F (-37 °C)	10.6 US qt (10.00 l)
-49 °F (-45 °C)	11.6 US qt (11.0 l)



## Consumer Information

This has been prepared as required of all manufacturers of passenger cars under Title 49, Code of U.S. Federal Regulations, Part 575 pursuant to the "National Traffic and Motor Vehicle Safety Act of 1966".

## Uniform Tire Quality Grading

Refer to the tire sidewall for the specific tire grades for the tires with which this vehicle is equipped.

All passenger car tires must conform to federal safety requirements in addition to these grades.

### Treadwear

The treadwear grade is a comparative rating based on the wear rate of the tire when tested under controlled conditions on a specified government test course. For example, a tire graded 150 would wear one and one-half (1½) times as well on the government course as a tire graded 100. The relative performance of tires "depends upon the actual conditions of their use, however

and may depart significantly from the norm due to variations in driving habits, service practices and differences in road characteristics and climate.

### Traction "A", "B", "C"

The traction grades, from highest to lowest, are "A", "B" and "C" and they represent the tire's ability to stop on wet pavement as measured under controlled conditions on specified government test surfaces of asphalt and concrete. A tire marked "C" may have poor traction performance.

### Warning!

**The traction grade assigned to this tire is based on braking (straight ahead) traction tests and does not include cornering (turning) traction.**

### Temperature "A", "B", "C"

The temperature grades are "A" (the highest), "B" and "C", representing the tire's resistance to the generation of heat and its ability to dissipate heat when

tested under controlled conditions on a specified indoor laboratory test wheel. Sustained high temperature can cause the material of the tire to degenerate and reduce tire life, and excessive temperature can lead to sudden tire failure. The grade "C" corresponds to a level of performance which all passenger car tires must meet under the Federal Motor Vehicle Safety Standard No. 109. Grades "B" and "A" represent higher levels of performance on the laboratory test wheel than the minimum required by law.

### Warning!

**The temperature grade for this tire is established for a tire that is properly inflated and not overloaded. Excessive speed, underinflation, or excessive loading, either separately or in combination, can cause excessive heat build up and possible tire failure.**

## **Problems with your Vehicle**

If you should experience a problem with your vehicle, particularly one that you believe may affect its safe operation, we urge you to immediately contact your authorized Mercedes-Benz dealer to have the problem diagnosed and corrected if required. If the matter is not handled to your satisfaction, please discuss the problem with the dealership management, or if necessary contact the Owner Service Manager at the Mercedes-Benz Regional Office nearest you (see Owner's Service and Warranty Information booklet for addresses). You may also write directly to us at the following addresses:

In the U.S.A.:           Owner Service Department  
                              Mercedes-Benz of North America Inc.  
                              One Mercedes Drive  
                              Montvale, NJ 07645-0350

In Canada:             Owner Service Department  
                              Mercedes-Benz Canada Inc.  
                              849 Eglinton Avenue East  
                              Toronto, Ontario, M4G 2L5

For the U.S.A. only.

The following text is published as required of manufacturers under Title 49, Code of U.S. Federal Regulations, Part 575 pursuant to the "National Traffic and Motor Vehicle Safety Act of 1966".

### **Reporting Safety Defects**

If you believe that your vehicle has a defect which could cause a crash or could cause injury or death, you should immediately inform the National Highway Traffic Safety Administration (NHTSA) in addition to notifying Mercedes-Benz of North America Inc..

If NHTSA receives similar complaints, it may open an investigation, and if it finds that a safety defect exists in a group of vehicles, it may order a recall and remedy campaign. However, NHTSA cannot become involved in individual problems between you, your dealer, or Mercedes-Benz of North America Inc..

To contact NHTSA, you may either call the Auto Safety Hotline toll-free at 1-800-424-9393 (or 366-0123 in Washington, D.C. area) or write to: NHTSA, U.S. Department of Transportation, Washington, D.C. 20590. You can also obtain other information about motor vehicle safety from the Hotline.



**Index:**

ABS [81](#), [95-97](#)  
ADS [99](#), [120](#), [140](#)  
Air conditioner refrigerant [142](#)  
Air distribution [25](#)  
Air volume [25](#)  
Airbag [53](#)  
Airbag deactivation system [51](#)  
Alarm system [38](#)  
Antenna [75](#), [127](#)  
Anticorrosion/antifreeze [101](#), [105](#),  
[141](#), [144](#)  
Antilock brake system (ABS) [95](#)  
Antitheft alarm system [38](#)  
Armrest, front [44](#)  
Armrest, rear [47](#)  
Ashtrays [68](#)  
Automatic climate control  
    Activated charcoal filter [23](#), [26](#)  
    Air recirculation [23](#), [25](#) - [26](#)  
    Basic setting [24](#)  
    Dust filter [25](#)  
    Economy [23](#) - [24](#), [26](#)  
    Special setting  
        Defogging windows [24](#)  
        Defrosting [24](#)  
Automatic transmission fluid level [106](#)

BabySmart™ [51](#)  
BAS [96-97](#)  
Battery [120](#)  
Battery not being charged  
    Charge indicator lamp [16](#), [88](#)  
Brake assist system [96](#)  
Brake fluid [17](#), [93](#), [124](#), [140](#), [142](#)  
Brake pads worn  
    Brake pad wear indicator lamp  
        [92](#)  
Brake warning lamp  
Brake fluid low [93](#)  
Brake warning lamp test [93](#)  
Brakes [17-18](#), [78](#), [80-81](#), [84-85](#), [96-](#)  
[97](#), [123](#)

Capacities: Fuels, coolants,  
    lubricants etc. [140](#)  
Catalytic converter [15](#)  
Cellular telephone [75](#)  
Central locking switch [34](#)  
Central locking system [29](#)  
Check regularly and before a long  
    trip [156](#)  
Child restraint [41](#), [44](#), [48](#), [51](#), [56-57](#)  
Cleaning and care of the vehicle [124](#)  
Clock, setting [73](#)  
Combination switch [59](#)  
Consumer information [145](#)  
Coolant level low  
    Adding coolant [105](#)  
    Low engine coolant level  
        warning lamp [91](#)  
    Coolant level, checking [105](#)  
Coolant temperature gauge [90-91](#),  
[104-105](#)  
Coolants [144](#)  
Cruise control [83](#)

Daytime running lamps [61](#)  
Display illumination [73](#)  
Doors [33](#)  
Drinking and driving [78](#)  
Driving instructions [17](#)  
Driving off [78](#)

Electronic stability program (ESP)  
[97](#), [99](#)

Emergency tensioning retractor (ETR) [52](#)

Emission control [100](#)

Emission control label [136](#)

Engine malfunction "CHECK ENGINE"  
malfunction indicator lamp [82](#), [100](#)

Engine oil consumption [89](#)

Engine oil level low  
Low engine oil level warning  
lamp [106](#)

Engine oil level, checking [106](#)

Engine oil pressure gauge [16](#), [88](#)

Engine oils [140](#), [142](#)

Engine overheating [90](#)

Engine speed limit Overrewing [81](#)

ESP [95-98](#), [101](#)

Exterior lamp failure indicator lamp [92](#)

Exterior lamp switch [61](#)

First aid kit [67](#)

Flexible service system [93](#)

FSS [14](#), [93-94](#)

Fuel  
Gasoline additives [143](#)  
Premium unleaded gasoline  
[15](#), [141-142](#)

Fuel cap placement warning [89](#)

Fuel consumption gauge [89](#)

Fuel filler flap, manual release [132](#)

Fuel Requirements [143](#)

Fuel reserve warning lamp [89](#)

Fuses [121](#)

Garage door opener [74](#)

Head restraints, front [39](#)

Head restraints, rear [46](#)

Head restraints, removal [129](#)

Headlights [61](#)

Heated seats [43](#)

Hood [104](#)

Identification labels [136](#)

Indicator lamp symbols [13](#)

Instrument cluster [12](#)

Instrument lamps [73](#)

Interior lighting [65](#)

Jump starting [121](#)

Keys, vehicle [28](#)

Lamps, exterior Fog  
lamps [61](#)  
Headlamps [61](#), [92](#), [114](#), [118](#)  
High mounted stop lamp [92](#)  
License plate lamp [61](#), [119](#)  
Standing lamps [61](#), [69](#)  
Taillamps [61](#), [119](#), [125](#)

Layout of poly-V-belt drive [133](#)

Lighter [68](#)

Locking and unlocking [29](#) - [30](#)

Low engine oil Level warning lamp [89](#)

Maintenance [4](#), [7](#)

Memory  
Recalling [40-41](#)  
Storing [40](#), [47](#), [63](#), [108](#), [112](#)

Mirror, inside, rear view [62](#)

Mirrors, adjusting [62](#)

Mirrors, exterior, rear view [62](#)

Multicontour backrest [42](#)

Night security illumination [62](#)

Outside temperature indicator [90](#)

- Parking assist (Parktronic) [85](#)
- Parking brake [16-17](#), [19](#), [68](#), [78-81](#), [93](#),  
[97](#), [100](#), [108](#), [110](#), [122](#)
- Power closing assist for doors and  
trunk lid [37](#)
- Power seats, front [39](#)
- Power seats, rear [45](#)
- Power windows
  - Opening and closing [29](#), [70](#) - [71](#)
  - Synchronizing remote control [128](#)
- Problems with your vehicle [146](#)
- Radio transmitters [7](#)
- Reading lamps [65](#)
- Rear bench seat cushion [130](#)
- Rear passenger compartment  
climate control [27](#)
- Rear window defroster [24](#)
- Rear window sunshade [72](#)
- Remote control [29](#), [128](#)
- Replacing bulbs [115](#)
- Residual engine heat utilization [26](#)
- Roadside assistance [5](#)
- Roof rack [133](#)
- Safety guidelines for the seat belt,  
emergency tensioning retractor  
and airbag [56](#)
- Seat belt warning lamp [92](#)
- Seat belts and warning system [48](#)
- Shelf below rear window [72](#)
- Sliding/pop-up roof [29](#), [32](#), [36](#),  
[69](#), [130](#)
  - Electrical operation [69](#)
  - Emergency operation [130](#)
- Snow chains [101](#)
- Spare parts service [133](#)
- Spare wheel [107](#)
- Special settings [24](#)
- SRS malfunction [53](#)
- Start lock-out [29](#)
- Starting and turning off the engine  
[16](#)
- Steering lock [58](#)
- Steering wheel, adjustable [47](#)
- Storage compartments [66](#)
- Stowing things in the vehicle [67](#)
- Sun visors [64](#)
- Supplemental restraint system  
(SRS) [48](#), [52](#)
- Tachometer [90](#)
- Technical data [138](#)
- Tire inflation pressure [113](#)
- Tires [17-19](#), [96-98](#), [101](#), [109](#)-  
[110](#), [113](#), [138](#), [145](#)
- Towing the vehicle [123](#)
- Transmission [79](#)
- Traveling abroad [101](#)
- Trip odometer [73](#)
- Trunk [35](#)
- Trunk lamp [107](#)
- Trunk lid
  - Manual closing [132](#)
  - Release switch [72](#)
- Trunk, remote opening [31](#)
- Trunk, separately locked [35](#)
- Turn signals [59](#)
- Vanity mirrors [64](#)
- Vehicle data card
- Vehicle jack [108](#)
- Vehicle tools [108](#)
- Warranty coverage [137](#)
- Washing the car [125](#)
- Wheels
  - Alloy wheels [127](#)
  - Rims and tires [109](#)
- Wheels, changing [110](#)
- Windshield/headlamp washer system
  - Fluid level low [91](#)
  - Washer fluid mixing ratio [60](#)
- Winter driving [101](#)
- Winter driving instructions [20](#)
- Wiper blades, replacing [131](#)







## **Service and Literature**

Your authorized Mercedes-Benz dealer has trained technicians and original Mercedes-Benz parts to service your vehicle properly. For expert advice and quality service, see your authorized Mercedes-Benz dealer.

If you are interested in obtaining service literature for your vehicle, please contact your authorized Mercedes-Benz dealer.

We consider this to be the best way to obtain accurate information for your vehicle.

## **Warning!**

**To help avoid personal injury, be extremely careful when performing any maintenance work or repairs. Improper or incomplete service may damage the vehicle or its equipment, which may in turn result in personal injury.**

**If you have any question about carrying out some service, turn to the advice of an authorized MERCEDES-BENZ dealer.**

## Check Regularly and Before a Long Trip

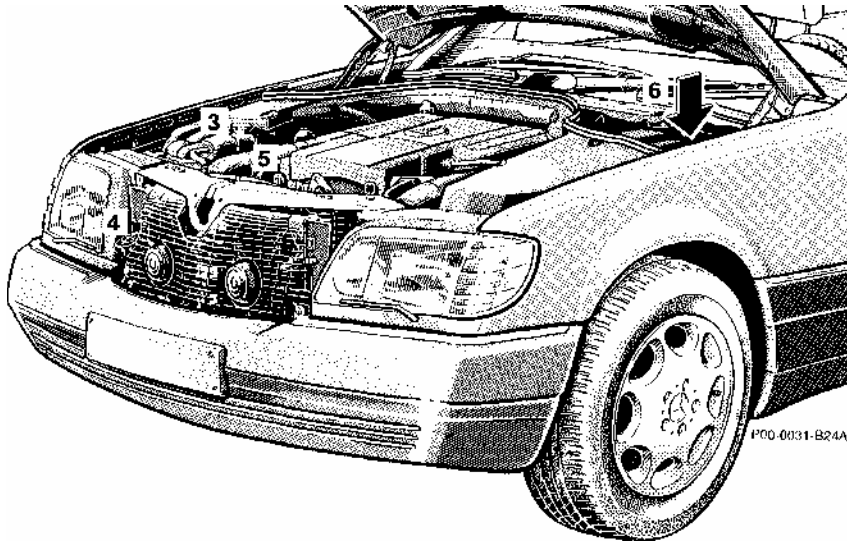
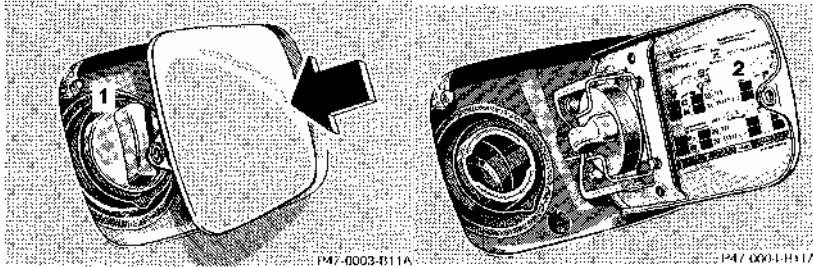

### 1 Fuel Supply

To add fuel turn cap to the left and hold on to it until possible pressure in tank has been released, then remove cap. Failure to do so could result in personal injury.

### 2 Tire Inflation Pressure

Check at least every two weeks. For details see Index.

### 3 Coolant Level

See *Adding coolant* in Index.

### 4 Windshield Washer System, Headlamp Cleaning System

For refilling reservoir see Index.

### 5 Engine Oil Level

See Index.

### 6 Brake Fluid

See Index.

### Vehicle Lighting:

Check function and cleanliness. For replacement of light bulbs, see Index.

## What You Should Know at the Gas Station

- **Fuel:**

Use premium unleaded gasoline: Posted Octane index 91 (Average of 96 RON/86 MON).

Fuel tank capacity approx. 21.1 US gal (80 l). This includes approx .26 US gal (10 l) reserve.

Only fill fuel tank until the filler nozzle unit cuts out - do not overfill.

### Warning!

**Gasoline vapor is highly flammable. It burns violently and can cause serious injury. Whenever you are around gasoline, extinguish all smoking materials. Never get sparks, flame or smoking materials near gasoline!**

- **Engine Oil:**

Engine oil level check, see Index.

Quantity differential between upper and lower dipstick marking level: 2.1 US qt (2.0 l).

Recommended engine oils, see Index.

- **Automatic Transmission:**

Automatic transmission fluid. For level checks refer to Index.

- **Coolant:**

For normal replenishing, use water (potable water quality). For further information (e.g. anticorrosion/antifreeze), refer to Index.

- **Spark Plugs:**

Approved spark plugs, refer to "Technical Data" (also see Index).

- **Bulbs:**

High and low beams: Halogen type 9004,  
fog lamps: Halogen type H 1 (55 W),  
tail, parking, standing and driver's side  
rear fog lamp 21/4 W/ 35/ 1.2 cp,  
turn signal, standing, side marker and parking  
lamps, front 21/5 W/ 32P/3 cp,  
turn signal lamps, rear 21W/ 32 cp,  
stop lamps 21 W/ 32 cp,  
license plate lamps 5 W.

- **Tire Pressure:**

For tire pressure, refer to tire pressure inside the fuel filler flap.

- **Air Conditioner:**

R-134a refrigerant and special lubricant (in selected vehicles - see underhood label), refer to "Technical Data" (also see Index).